

On the effects of membrane viscosity on transient red blood cell dynamics

F. Guglietta,^{1,2,3,*} M. Behr,² L. Biferale,¹ G. Falcucci,^{4,5} and M. Sbragaglia¹

¹*Department of Physics & INFN, University of Rome “Tor Vergata”,
Via della Ricerca Scientifica 1, 00133, Rome, Italy.*

²*Chair for Computational Analysis of Technical Systems (CATS), RWTH Aachen University,
52056 Aachen, Germany*

³*Computation-based Science and Technology Research Center, The Cyprus Institute,
20 Konstantinou Kavafi Str., 2121 Nicosia, Cyprus*

⁴*Department of Enterprise Engineering “Mario Lucertini,” University of Rome “Tor Vergata”,
Via del Politecnico 1, 00133 Rome, Italy*

⁵*John A. Paulson School of Engineering and Applied Physics, Harvard University,
33 Oxford Street, 02138 Cambridge, Massachusetts, USA*

Computational Fluid Dynamics (CFD) is currently used to design and improve the hydraulic properties of biomedical devices, wherein the large scale blood circulation needs to be simulated by accounting for the mechanical response of red blood cells (RBCs) at mesoscales. In many practical instances, biomedical devices work on time-scales comparable to the intrinsic relaxation time of RBCs: thus, a systematic understanding of the *time-dependent* response of erythrocyte membranes is crucial for the effective design of such devices. So far, this information has been deduced from experimental data, which do not necessarily adapt to the the broad variety of the fluid dynamic conditions that can be encountered in practice. This work explores the novel possibility of studying the time-dependent response of an erythrocyte membrane to external mechanical loads via ab-initio, mesoscale numerical simulations, with a primary focus on the detailed characterisation of the RBC relaxation time t_c following the arrest of the external mechanical load. The adopted mesoscale model exploits a hybrid Immersed Boundary-Lattice Boltzmann Method (IB-LBM), coupled with the Standard Linear Solid model (SLS) to account for the RBC membrane viscosity. We underscore the key importance of the 2D membrane viscosity μ_m to correctly reproduce the relaxation time of the RBC membrane. A detailed assessment of the dependencies on the typology and strength of the applied mechanical loads is also provided. Overall, our findings open interesting future perspectives for the study of the non-linear response of RBCs immersed in time-dependent strain fields.

PACS numbers: 47.11.-j *Computational methods in fluid dynamics*; 87.16.Dg *Membranes, bilayers, and vesicles*; 47.15.G- *Low-Reynolds-number (creeping) flows*; 87.10.+e *General theory and mathematical aspects*.

Keywords: Lattice Boltzmann, Immersed Boundary Method, Biological fluid dynamics, Red Blood Cells, Membrane viscosity.

I. INTRODUCTION

Blood is a heterogeneous non-Newtonian fluid, mainly composed by plasma (a Newtonian fluid which constitutes approximately the 55% of the total volume) and red blood cells (RBCs) (the hematocrit, i.e. the concentration of erythrocytes within the blood, ranges between 37% to 50%, according to age and sex) [1–3]. On one hand, the information on the mechanical and biochemical responses of RBC membrane can give useful information on human health state [4]. On the other hand, it can be used to improve the design of biomedical equipment, such as Ventricular Assist Devices (VADs), which have been developed in the years to assist blood circulation in patients with heart failures [5–7]. The optimal design of VADs requires a thorough understanding of the fluid dynamic field inside these devices, something not realisable from experimental measurements due to the difficulty to have non intrusive probes dispersed in the fluid volume. Computational Fluid Dynamics (CFD) offers a solution to this problem, and it has been extensively used to improve VADs hydraulic properties, through the simulation of their internal blood circulation, and providing an augmented reality representation of the flow field inside the whole device [8–13]. One of the most challenging aspects in designing VADs is connected to the reduction of hemolysis, [5, 14], that is the release of the cytoplasm (i.e. the fluid inside the membrane of the RBC). Hemolysis is directly connected to the fluid-dynamical stress experienced by RBC membrane [14, 15]. The corresponding CFD framework is rather challenging, due to the intrinsic *multiscale* nature of the involved physics, with erythrocytes (characterised by an average diameter

*Electronic address: guglietta@roma2.infn.it

of $d \sim 9 \times 10^{-6}$ m, at rest), evolving within the VAD, whose internal chambers are in the order of ~ 0.01 m. In addition, RBC dynamics within the VAD is *non-steady*, since their residence time through the device is comparable to their membrane (intrinsic) relaxation time, ~ 0.500 s [14]. To account for these complex characteristics, Arora *et al.* [14] developed a “tensor-based” model (also known as strain-based model), in which the time-dependent shape of a single RBC is described by a differential equation that accounts for a few mesoscale parameters. Such a slender model is, then, coupled to the Navier-Stokes hydrodynamics within the VADs [15–17] through Finite Element (FEM) simulations. Hemolysis is then quantified in terms of the ratio between plasma free haemoglobin to total haemoglobin (i.e. $\Delta Hb/Hb$), which depends on the effective shear rate. Such a tensor-based approach allows for a convenient and efficient multiscale simulation: given few “mesoscale”, non-steady parameters in input (such as the membrane relaxation time t_c , the degree of time-dependent deformation under flow), a “large scale” numerical simulation of the pump can be carried out, with the aim of designing a suitable geometry that minimises hemolysis [16–18]. So far, the free mesoscale parameters needed by Arora’s model have been recovered from experimental data [19], which do not obviously adapt to the broad variety of conditions that can be encountered in practice. In particular, some delicate issues pertain the relaxation time t_c of RBCs after the arrest of external mechanical loads: viscous effects play a key role and come both from the internal (cytoplasm) and external (plasma) fluid, and from the membrane itself. Pioneering experimental studies focused on the relaxation of RBCs in a variety of experimental set-ups [19–22], while more recent experiments target the shape deformation time in microfluidic set-ups [23]. In these experiments, membrane viscosity μ_m has shown a direct role in determining the relaxation time of the whole RBC [23–25], with old erythrocytes characterised by a higher membrane viscosity compared to younger cells [19, 25]. The membrane viscosity is not known *a priori* and is usually computed indirectly from t_c , with larger membrane viscosities generically associated to larger relaxation times. For an accurate determination, various phenomenological models have been proposed in the literature [24, 26], resulting in consistent discrepancies in the values of μ_m .

In this heterogeneous panorama, the comprehensive characterisation of the RBC relaxation time at the sudden arrest of an external mechanical load – considering the membrane viscosity as a variable rather than a fixed input parameter – is still lacking. Experimental data, in fact, do not allow a comprehensive characterisation of this phenomenon, due to the intrinsic difficulties in isolating the effects of membrane properties and external/internal flow properties. Rather, mesoscale simulations represent a more appropriate tool, wherein one can easily modify physical properties such as membrane characteristics (elasticity, viscosity), or focus on the specific flow conditions that trigger membrane peculiar responses. It must be remarked, however, that while mesoscale simulations of RBCs have been carried out in a variety of contexts [1, 2, 27–36], the focus has never been put on the full characterisation of the relaxation time of RBCs after the cessation of an external load, at changing systematically the strength of the mechanical load and the values of membrane viscosity. This paper aims at taking a step further in this direction.

We exploit the combined Immersed Boundary - Lattice Boltzmann Method (IB-LBM) described in Krüger [1], in which the elastic behaviour of RBCs is rendered through the Skalak model [37] supplemented by a bending energy [1, 38]. The quantitative details are accurately tuned by means of real RBCs properties. We account for membrane viscosity, as well, following the Standard Linear Solid model (SLS) [39]: the magnitude of membrane viscosity is kept as a free parameter in the simulations. Our viscoelastic membrane model is quantitatively validated following a simple-to-complex trajectory: first, we study the deformation of a droplet in simple shear flow, whose elastic properties at the interface are given by surface tension; the latter is further supplemented by an interfacial viscosity. Then, in the same setup, we look at the deformation of a spherical capsule, whose interface is made by a thin membrane and its elastic behaviour is given by Skalak model; the latter is supplemented by membrane viscosity. Finally, we move to RBCs (note that, in our definition, a RBC is a capsule with a biconcave shape). The relaxation time of RBCs will then be quantitatively studied as a function of the membrane viscosity μ_m and the strength of mechanical loads imposed on the RBCs. We will show that implementing viscosity in the membrane model is crucial for capturing the dynamics of a real RBC. Moreover, we will perform simulations in two different setups: in the first one, we simulate the stretching of a single RBC in optical tweezers; in the second one, the RBC deforms under the action of an imposed shear flow. In general, it is found that the increase in the membrane viscosity results in a slower recovery dynamics. At fixed membrane viscosity, the systematic study at changing the strength and typology of mechanical load reveals other interesting properties: while in the limiting case of vanishing load strength the recovery dynamics is independent of the applied mechanical load, for finite load strengths it shows faster dynamics with non universal features that markedly depend on the loading mechanism.

The paper is organised as follows. In Sec. II we present the numerical model chosen for the RBC modelling. In Sec. III some benchmark simulations against known literature data will be provided. Results on the relaxation properties of RBCs will be presented in Sec. IV. Conclusions will be drawn in Sec. V.

II. METHODOLOGY: IMMERSSED BOUNDARY - LATTICE BOLTZMANN METHOD (IB-LBM)

A. Numerical model for fluid solver and flow-structure coupling

The hydrodynamical fields inside and outside RBCs are analysed through the Lattice Boltzmann Method (LBM), while the coupling with the Lagrangian structures is achieved via the immersed boundary (IB) method. The hybrid IB-LBM is already fully detailed in the literature [1, 40, 41]: some essential features of the methodology are here recalled, while more extensive details can be found in dedicated books [41, 42].

LBM is a numerical approach which is grounded on the discretisation of Boltzmann Kinetic Equation [41, 42], rather than on the continuum assumption, which is at the basis of Navier-Stokes approach. LBM hinges on the dynamical evolution of fluid molecules distribution functions, $f_i(\mathbf{x}, t)$, which represent the density of fluid molecules with velocity \mathbf{c}_i at position \mathbf{x} and time t :

$$f_i(\mathbf{x} + \mathbf{c}_i \Delta t, t + \Delta t) - f_i(\mathbf{x}, t) = -\frac{\Delta t}{\tau} \left(f_i(\mathbf{x}, t) - f_i^{(\text{ea})}(\mathbf{x}, t) \right) + f_i^{(F)} \quad (1)$$

in which τ is the relaxation time, $f_i^{(F)}$ is the force density (which has been implemented according to the so-called ‘‘Guo’’ scheme [43]) and $f_i^{(\text{ea})}(\mathbf{x}, t)$ is the equilibrium distribution function [44]:

$$f_i^{(\text{ea})} = w_i \rho \left(1 + \frac{\mathbf{c}_i \cdot \mathbf{u}}{c_s^2} + \frac{(\mathbf{c}_i \cdot \mathbf{u})^2}{c_s^4} - \frac{\mathbf{u} \cdot \mathbf{u}}{c_s^2} \right). \quad (2)$$

In Eq. (2), ρ is the fluid density and c_s is the speed of sound. In the velocity set $\{\mathbf{c}_i\}$ that we have chosen, it results $c_s^2 = (1/3)(\Delta x/\Delta t)^2$. Note that, since we are interested in simulating two different fluids (one outside and one inside the membrane of a capsule), the relaxation time is not constant but it depends on the position, i.e. $\tau = \tau(\mathbf{x})$.

From the evolution of the distribution function $f_i(\mathbf{x}, t)$, we retrieve the most important (macroscopic) hydrodynamics quantities, that are the density ρ and the velocity of the fluid \mathbf{u} :

$$\rho(\mathbf{x}, t) = \sum_i f_i(\mathbf{x}, t), \quad \rho \mathbf{u}(\mathbf{x}, t) = \sum_i \mathbf{c}_i f_i(\mathbf{x}, t) \quad (3)$$

where the sum runs over the discrete directions.

The link between the Navier-Stokes equation and the LBM, given by the Chapman-Enskog analysis, provides the relation between the LB relaxation time τ and the viscosity of the fluid μ_{out} [41]:

$$\mu_{\text{out}} = \rho c_s^2 \left(\tau - \frac{\Delta t}{2} \right). \quad (4)$$

We also define the viscosity ratio $\tilde{\mu}$ as the ratio between the inner fluid and outer fluid viscosities:

$$\tilde{\mu} = \frac{\mu_{\text{in}}}{\mu_{\text{out}}}. \quad (5)$$

In this work, we use LBM to simulate flows in the Stokes limit (see Sec. IIIB), that is for low Reynolds number $\text{Re} = \dot{\gamma} \rho r^2 / \mu_{\text{out}}$, where $\dot{\gamma}$ is the shear rate and r is the characteristic length, i.e. the radius of the spherical capsule/droplet (see Fig. 1) or the radius of the RBC at rest (see Fig. 5).

The fluid dynamics of LBM is further coupled with Lagrangian structures (such as the interface of a droplet or the membrane of a capsule) via the IB method [41]. The Lagrangian structure is represented by a finite number of Lagrangian points that can freely move through the Eulerian lattice. The velocity $\dot{\mathbf{r}}_j$ of the j -th Lagrangian point at position \mathbf{r}_j is computed by interpolating the fluid velocity \mathbf{u} of the neighbouring lattice sites \mathbf{x} by means of discrete Dirac delta functions $\Delta(\mathbf{r}_j(t), \mathbf{x})$:

$$\dot{\mathbf{r}}_j(t) = \sum_{\mathbf{x}} \Delta \mathbf{x}^3 \mathbf{u}(\mathbf{x}, t) \Delta(\mathbf{r}_j(t), \mathbf{x}). \quad (6)$$

The nodal force \mathbf{F}_j on the j -th Lagrangian node is computed and *passed* to the neighbouring lattice sites with the same interpolation adopted to compute the nodal velocity.

$$\mathbf{F}(\mathbf{x}, t) = \sum_j \mathbf{F}_j(t) \Delta(\mathbf{r}_j(t), \mathbf{x}). \quad (7)$$

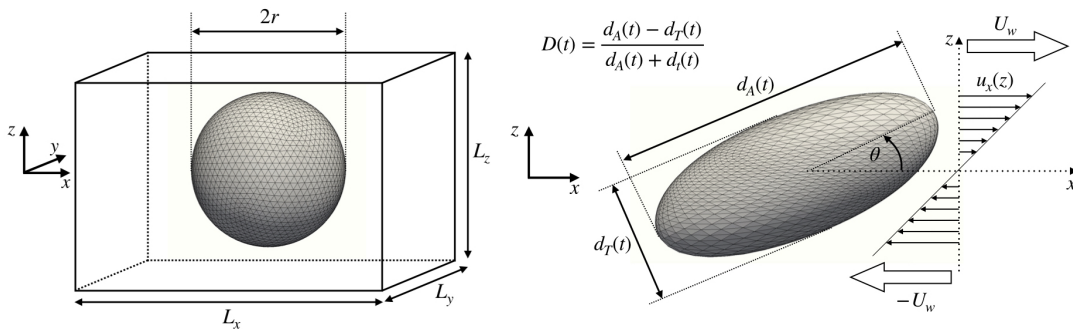

FIG. 1: Setup for the benchmarks on capsule/droplet deformation. The 3D mesh represents a spherical Lagrangian structure immersed in a fluid (cfr. Sec. II A) in a computational box of size $L_x \times L_y \times L_z$. The walls at $z = \pm L_z/2$ move with opposite velocities $\pm U_w$; U_w can be varied in order to impose a shear flow with prescribed intensity. Under the effect of the shear flow, the sphere deforms with major (d_A) and minor (d_T) axes in the shear plane: the deformation coefficient $D = (d_A - d_T)/(d_A + d_T)$ and the inclination angle θ are studied as functions of the flow properties. Different benchmark tests have been conducted: (i) Newtonian droplet deformation (cfr. Sec. III A) with additional surface viscosity; (ii) viscoelastic capsule deformation (cfr. Sec. III B), for which the Lagrangian structure models both elastic and viscous properties of the capsule membrane.

Such a nodal force \mathbf{F}_j is strongly related to the adopted membrane model (see Sec. II B). The Dirac delta function can be factorised in the interpolation stencils, $\Delta(\mathbf{x}) = \phi(x)\phi(y)\phi(z)/\Delta x^3$ [40, 41]. We adopt the 4-point interpolation stencil:

$$\phi_4(x) = \begin{cases} \frac{1}{8} \left(3 - 2|x| + \sqrt{1 + 4|x| - 4x^2} \right) & 0 \leq |x|; \\ \frac{1}{8} \left(5 - 2|x| - \sqrt{-7 + 12|x| - 4x^2} \right) & \Delta x \leq |x| \leq 2\Delta x; \\ 0 & 2\Delta x \leq |x|. \end{cases} \quad (8)$$

Finally, in order to recognise which lattice sites are enclosed by the Lagrangian structure at each time step, we have implemented the parallel Hoshen-Kopelman algorithm [45]. Briefly, each processor first recognises the lattice sites near the Lagrangian structure, and by using the outgoing normal for each face it distinguishes which of these sites are inner and which outer; then, it assigns different labels for lattice sites in different clusters; finally, all the processors communicate the labels and by looping over the lattice domain they recognise whether a lattice site is inside or outside the Lagrangian structure. Extensive details can be found in [45].

B. Membrane model

The configurational properties of the membrane are defined through its free energy W , whose main contributions are the bending [38, 46] and the strain [37] energies. These two terms are implemented as proposed in [1]. We further introduce the membrane viscosity, by employing the algorithm proposed by Li and Zhang [39]. In the following Subsections, we recall the main ingredients of the aforementioned implementations.

Bending and Strain

The bending term is introduced to take into account that the RBC has a bilayer membrane. We adopt Helfrich formulation to describe the bending resistance [38, 46]. The free energy W_B is given by [1]:

$$W_B = \frac{k_B}{2} \int_{\Sigma} \left(H - H^{(0)} \right)^2 d\Sigma \quad (9)$$

where H is the trace of the surface curvature tensor, $H^{(0)}$ is the spontaneous curvature and Σ is the capsule surface area; k_B is the *bending modulus*, whose value is reported in the table of Fig. 5 [38]. Following [1], we discretise Eq. (9) as follows:

$$W_B = \frac{k_B \sqrt{3}}{2} \sum_{\langle i,j \rangle} \left(\theta_{ij} - \theta_{ij}^{(0)} \right)^2 \quad (10)$$

where the sum runs over all the neighbouring triangular elements, and θ_{ij} is the angle between the normals of the i -th and j -th elements (note that $\theta_{ij}^{(0)}$ is the same angle in the unperturbed configuration). The strain contribution to the total free energy can be written as [37]

$$W_S = \sum_j w_S^{(j)} A_j \quad (11)$$

where $w_S^{(j)}$ is the area energy density related to the j -th element with surface area A_j [37]

$$w_S^{(j)} = \frac{k_S}{8} (I_1^2 + 2I_1 - 2I_2) + \frac{k_\alpha}{8} I_2^2 \quad (12)$$

where $I_1 = \lambda_1^2 + \lambda_2^2 - 2$ and $I_2 = \lambda_1^2 \lambda_2^2 - 1$ are the strain invariants for the j -th element, while λ_1 and λ_2 are the principal stretch ratios [1, 37]: note that λ_1 and λ_2 are the eigenvalues of the deformation gradient tensor \mathcal{F} . The coefficients k_S and k_α are the *surface elastic shear modulus* and the *area dilation modulus*, respectively: their physical values for the RBC membrane are reported in the table of Fig. 5 [38, 47]. Moreover, k_S is related to the Capillary number Ca , defining the relative importance of bulk viscous effects with respect to the elastic properties of the membrane:

$$\text{Ca} = \frac{\mu_{\text{out}} \dot{\gamma} r}{k_S} . \quad (13)$$

Once the total free energy $W = W_B + W_S$ is computed, the force acting on the i -th node at the position \mathbf{x}_i is retrieved:

$$\mathbf{F}_i = - \frac{\partial W(\mathbf{x}_i)}{\partial \mathbf{x}_i} . \quad (14)$$

Membrane viscosity

The viscosity of the membrane relates the 2D viscous stress $\boldsymbol{\tau}^\nu$ to the strain rate tensor $\dot{\mathbf{E}}$, i.e. the time derivative of the strain tensor:

$$\mathbf{E} = \frac{1}{2} (\mathbf{F}^T \mathbf{F} - \mathbb{1}) \quad (15)$$

where $\mathbb{1}$ is the 2-dimensional unit matrix. Two contributions can be identified in the strain rate tensor $\dot{\mathbf{E}}$, related to the shear (\bullet_s) and the dilatational (\bullet_d) contributions, respectively:

$$\dot{\mathbf{E}}_s = \dot{\mathbf{E}} - \frac{1}{2} \text{tr}(\dot{\mathbf{E}}) \mathbb{1} , \quad \dot{\mathbf{E}}_d = \frac{1}{2} \text{tr}(\dot{\mathbf{E}}) \mathbb{1} . \quad (16)$$

By introducing the shear and dilatational membrane viscosities (μ_s and μ_d , respectively), we can split the 2D viscous stress $\boldsymbol{\tau}^\nu$ in two parts:

$$\boldsymbol{\tau}^\nu = \boldsymbol{\tau}_s^\nu + \boldsymbol{\tau}_d^\nu = 2\mu_s \dot{\mathbf{E}}_s + 2\mu_d \dot{\mathbf{E}}_d = \mu_s (2\dot{\mathbf{E}} - \text{tr}(\dot{\mathbf{E}}) \mathbb{1}) + \mu_d \text{tr}(\dot{\mathbf{E}}) \mathbb{1} . \quad (17)$$

We employ the standard linear solid (SLS) model to describe the viscoelastic behaviour of the membrane [39, 48]: it can be considered as the linear combination of the Kelvin-Voigt model (in which a dashpot μ is connected in parallel with a spring k) and the Maxwell model (in which the dashpot μ and an artificial spring k' are connected in series). The Kelvin-Voigt model can successfully describe membrane creep, while the Maxwell model accurately characterises the stress relaxation; their combination, the SLS model, correctly accounts for both phenomena [49]. The value of k' has been tuned in order to retrieve the asymptotic behaviour of the Maxwell element [39]. The membrane viscosity properties are quantified via the Boussinesq numbers:

$$\text{Bq}_s = \frac{\mu_s}{\mu_{\text{out}} r} , \quad \text{Bq}_d = \frac{\mu_d}{\mu_{\text{out}} r} \quad (18)$$

accounting for shear and membrane dilation effects, respectively. Once the total stress $\boldsymbol{\tau}^T$ has been computed, the total force acting on the i -th node is given by

$$\begin{pmatrix} F_x^i \\ F_y^i \end{pmatrix} = \boldsymbol{\tau}^T \mathcal{F}^{-T} \nabla N_i A_m = (\boldsymbol{\tau}^\nu + \boldsymbol{\tau}^s) \mathcal{F}^{-T} \begin{pmatrix} a_i \\ b_i \end{pmatrix} A_m \quad (19)$$

where $N_i = a_i x + b_i y + c_i$ is the linear shape function of the m -th element, and A_m is the surface area of the m -th element (see [50] for more details). For the droplet with interfacial viscosity (Sec. III A), the total stress $\boldsymbol{\tau}^T$ is the sum of the viscous stress $\boldsymbol{\tau}^\nu$ and the surface tension stress $\boldsymbol{\tau}^s$; while for the viscoelastic capsule (Sec. III B), and then also for the RBC (Sec. IV), since the elastic force is directly computed from the free energy (see Eq. (14)), the total stress is $\boldsymbol{\tau}^T = \boldsymbol{\tau}^\nu$.

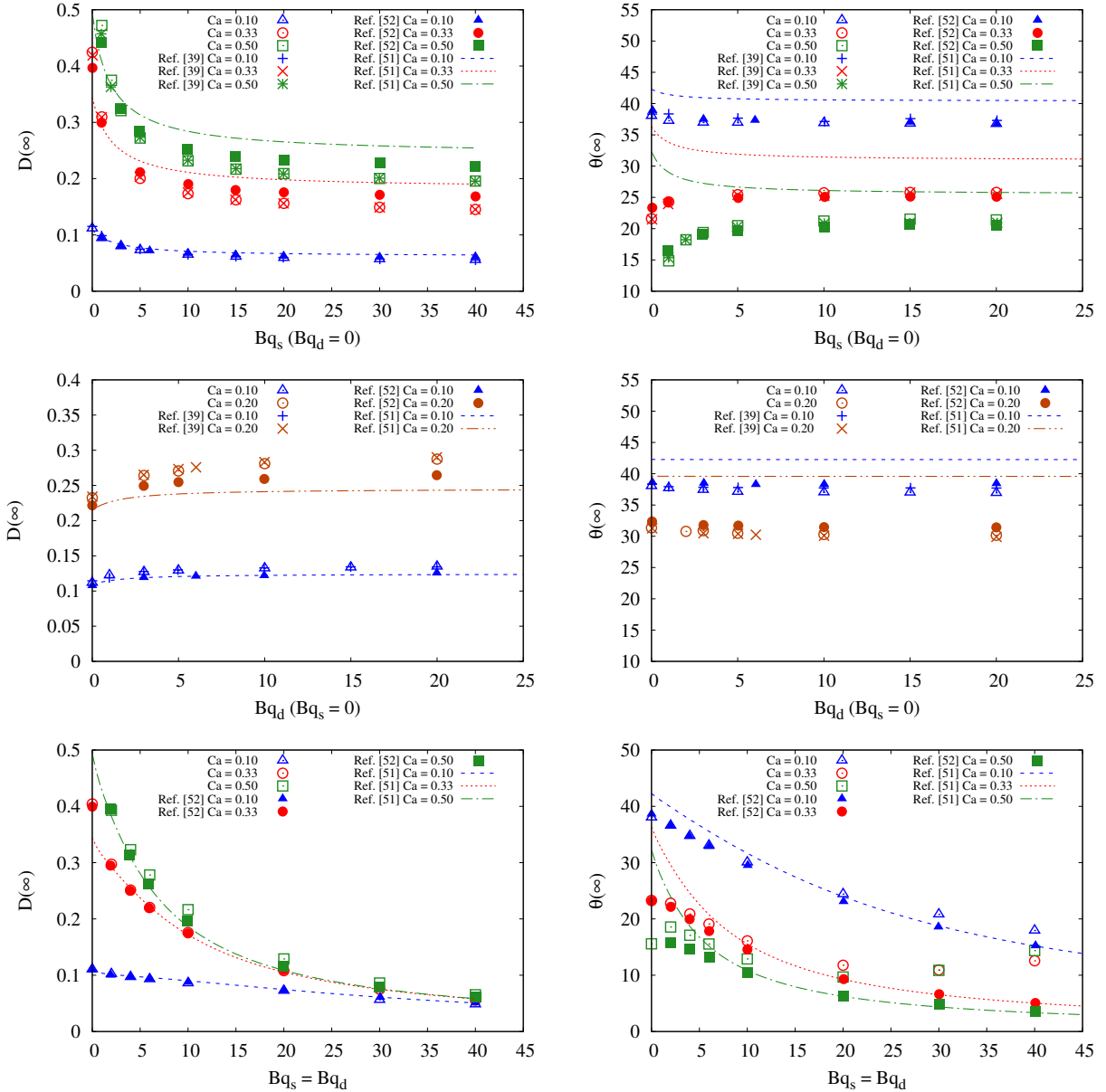

FIG. 2: Deformation of Newtonian droplet with interfacial viscosity in simple shear flow (see Fig. 1). We report the steady deformation $D(\infty)$ (Left panels) and inclination angle $\theta(\infty)$ (Right panels) as functions of the Capillary number $Ca = \frac{\mu_{out} \dot{\gamma} r}{\sigma}$, for different values of the Boussinesq numbers Bq_s and Bq_d (cfr. Eq. (18)). The results from numerical simulations are compared with the perturbative theoretical calculations by Flumerfelt [51], the Boundary Integral calculations by Gounley *et al.* [52] and the IB-LBM numerical simulations by Li & Zhang [39].

III. BENCHMARKS

To benchmark the numerical model, we conducted 3D simulations of an initially spherical Lagrangian structure (droplet or capsule) deforming in an imposed linear shear flow, within a domain of size $L_x \times L_y \times L_z$. Through the bounce-back method for moving walls [41], we set the wall velocity $\mathbf{U}_w = (\pm\dot{\gamma}L_z/2, 0, 0)$ on the two plane walls at $z = \pm L_z/2$ ($\mathbf{U}_w > 0$ for $z > 0$); periodic boundary conditions are set along x and y directions. The spherical structure will deform under shear, developing an inclination angle θ with respect to the flow direction (see Fig. 1). We define the deformation parameter D as

$$D = \frac{d_A - d_T}{d_A + d_T} \quad (20)$$

where d_A and d_T are the major and minor axes of the structure in the shear plane (see Fig. 1). We determine d_A and d_T via the three real eigenvalues T_1, T_2 and T_3 of the inertia tensor \mathbf{T} as $d_A = 2\sqrt{5(T_2 + T_3 - T_1)/(2M)}$ and $d_T = 2\sqrt{5(T_3 + T_1 - T_2)/(2M)}$, where M is the mass of the immersed object [1]. To compute the inclination angle θ , we consider the eigenvectors of \mathbf{T} .

To test both the elastic and the viscous models, we follow a simple-to-complex path: first, we consider a droplet, whose elastic response of the interface is given by the surface tension further supplemented by an interfacial viscosity implemented with the SLS model (see Sec. IIB). Then, we consider a spherical capsule, whose interface is made by a thin membrane and its elastic properties are given by the Skalak model (see Sec. IIB): for the spherical capsule, we first test only the Skalak model (i.e. without membrane viscosity); then, we implement the SLS model that has been already tested for the droplet. At the end of this section, we have a fully validated viscoelastic model that we use in Sec. IV to simulate a realistic RBC.

In these benchmarks, we represent both the droplet and the spherical capsule (see Fig. 1) via a 3D triangular mesh generated by a successive subdivision of a regular icosahedron.

A. Newtonian droplet with interfacial viscosity

In order to benchmark the implementation of membrane viscosity, we have investigated the deformation of a Newtonian droplet in shear flow, including the contribution of the surface viscosity at the droplet interface. The total stress on the interface is given by the sum of the viscous tensor $\boldsymbol{\tau}^\nu$ (17) and the surface tension tensor $\boldsymbol{\tau}^s = \zeta\mathbb{1}$ (with ζ the droplet surface tension). In order to quantify the response under a simple shear flow, we studied the steady state deformation of the droplet $D(\infty)$ and the inclination angle $\theta(\infty)$ (see Fig. 1) by varying the Capillary number $\text{Ca} = \frac{\mu_{\text{out}}\dot{\gamma}r}{\zeta}$, and the Boussinesq numbers Bq_s and Bq_d (cfr. Eqs. (18)), following the benchmarks proposed by Li & Zhang [39]. Thus, we adopt the same numerical parameters as in [39] and we further extend the validation by considering various choices of the Boussinesq numbers. We will also provide comparisons with the boundary integral calculations by Gounley *et al.* [52] and the theoretical predictions by Flumerfelt [51]. The results of our simulations, reported in Fig. 2, show an excellent agreement with those of Li & Zhang [39]. Some discrepancies emerge in the comparisons with the results of Flumerfelt [51] and Gounley *et al.* [52]. One has to notice, however, that Flumerfelt's calculations are perturbative in Ca , hence they are not suited to match the regimes at larger Ca , by definition. Moreover, while our calculations and those by Li & Zhang [39] are based on the LBM, Gounley *et al.* [52] solve the Stokes equations by means of the boundary element method; hence, the observed discrepancies with the results of Gounley *et al.* [52] may rise from the different fluid solvers. It is also interesting to note that such discrepancies are not observed when studying the steady state deformation with the condition $\text{Bq}_s = \text{Bq}_d$: with such a choice, the term $\text{Tr}(\dot{\mathbf{E}})$ disappears from the 2D viscous stress $\boldsymbol{\tau}^\nu$ (see Eq. (17)), which guarantees the incompressibility of the membrane. This would point to the fact that the observed dissimilarities with Gounley *et al.* [52] can originate from surface divergence terms of the velocity field. Further analysis is obviously needed to better address and quantify such discrepancies. In the following, RBC simulations will be performed with the choice $\text{Bq}_s = \text{Bq}_d$ [53].

B. Capsule with viscoelastic membrane

First, to benchmark the Skalak model (see Sec. IIB), we simulated the deformation of a purely elastic capsule (i.e. with no membrane viscosity) immersed in a linear shear flow: therefore, we use only the free-energy term related to the strain and area dilation given by Eq. (12). To benchmark our implementation, we performed the same set of simulations as those proposed by Krüger *et al.* [40], by varying the Reynolds number Re , the number of faces

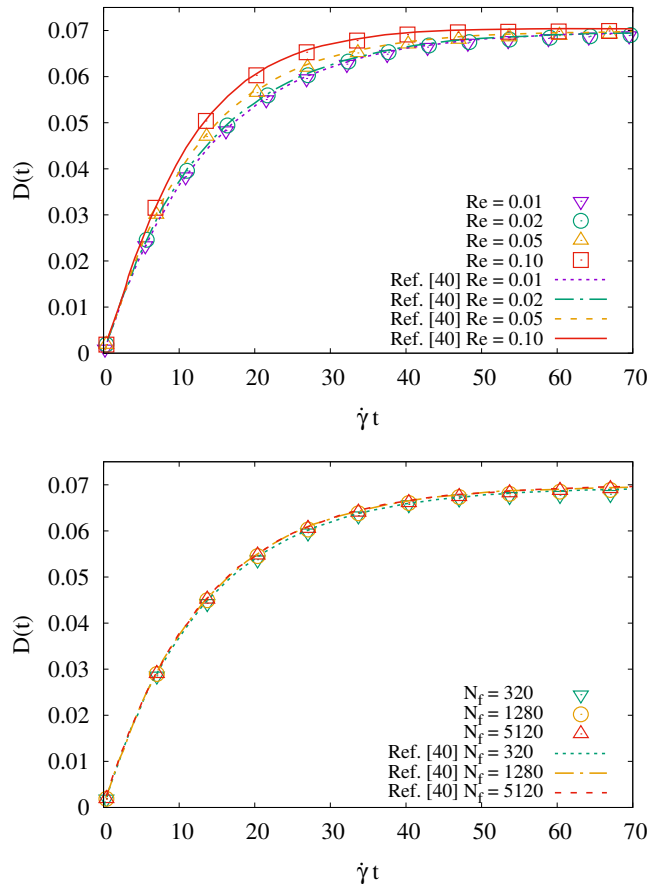

FIG. 3: Deformation of purely elastic capsule in simple shear flow (see Fig. 1). Top panel: we report the deformation parameter $D(t)$ (cfr. Eq. (20)) as a function of the dimensionless time $\dot{\gamma}t$, with $\dot{\gamma}$ the imposed shear rate; the Reynolds number Re is varied to test the convergence to the Stokes' limit. Bottom panel: we report $D(t)$ as a function of the dimensionless time $\dot{\gamma}t$ for a fixed Reynolds number $Re = 0.01$. In the panels, the trends are functions of the number of faces N_f used to discretise the 3D surface of the elastic sphere. Comparisons with data by Krüger *et al.* [40] (lines) are performed.

N_f , the aspect ratio L_z/r and the capillary number Ca : all the adopted parameters have exactly the same values as those in [40]. Some representative results are displayed in Fig. 3. In the top panel, we show the time evolution of the deformation parameter at changing the Reynolds number Re . The plot shows a neat asymptotic limit when Re decreases (Stokes' limit). The results indicate that $Re = 0.01$ is small enough to achieve a fair convergence. In the bottom panel, we show the time evolution of the deformation parameter $D(t)$ as a function of the number of faces N_f used to discretise the spherical capsule. A proper choice of N_f is, in fact, crucial both to avoid numerical errors due to a coarse mesh and to ensure the Hoshen-Kopelman algorithm to properly work [45]. Results indicate that $N_f = 5120$ is sufficient to make the numerical errors related to the mesh resolution negligible. As a further benchmark (results not shown), we have checked the deformation and the inclination angle by varying the LB relaxation time τ , the radius of the sphere r , the aspect ratio L_z/r and the interpolation stencil ϕ , finding an excellent agreement with the results presented in Krüger *et al.* [40], thus supporting the accuracy and rigor of the implemented methodology. Now we benchmark the numerical simulations in the presence of both elasticity and membrane viscosity. The reference data are those presented in Li & Zhang [39]. We adopted the very same numerical parameters as those in [39]; in particular, the elastic properties of the membrane are described by the Skalak model, with $k_\alpha = k_S$ (see Eq. (12)), supplemented with membrane viscosity with variable Bq_s and $Bq_d = 0$. In Fig. 4, we report the deformation $D(t)$ as a function of the dimensionless time $\dot{\gamma}t$: this figure highlights the satisfactory agreement with the results by Li & Zhang [39]. In particular, oscillations in the transient dynamics are observed, which are dumped at large simulation times. Those oscillations are more pronounced at the larger Bq_s and their dumping time is an increasing function of Bq_s . Notice that due to the absence of the bending term, some wrinkles may appear on the surface [39], and the shape of the capsule can be slightly different from an ellipsoid. This could be the cause of the very slight misalignment between the two sets of data.

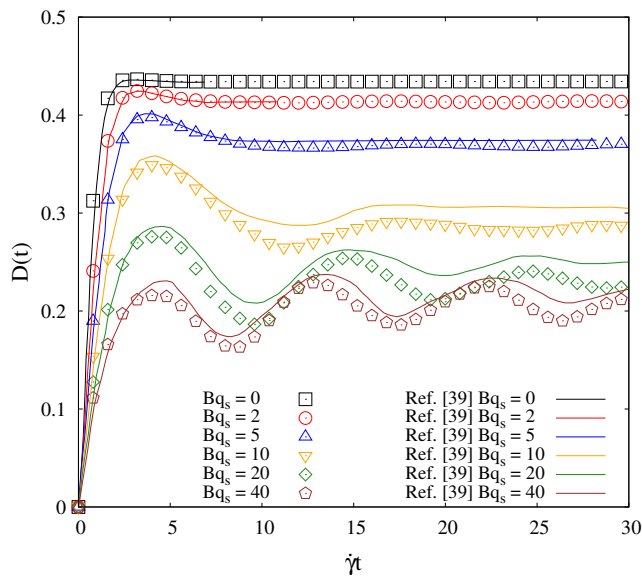
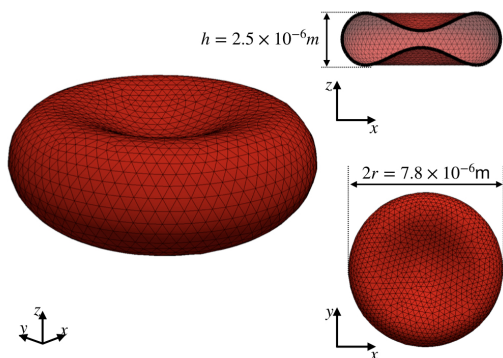

FIG. 4: Deformation of a viscoelastic capsule in simple shear flow with prescribed intensity of the shear rate $\dot{\gamma}$ (see Fig. 1). We report the time evolution of the deformation parameter $D(t)$ (cfr. Eq. (20)) as a function of the dimensionless time $\dot{\gamma}t$. We vary the Boussinesq number Bq_s while keeping $Bq_d = 0$ (cfr. Eqs. (18)). Results from numerical simulations are compared with the IB-LBM data provided by Li & Zhang [39].



RBC PARAMETERS	
Radius r	3.91×10^{-6} m [1]
Area A	133×10^{-6} m ²
Volume V	93×10^{-6} m ³
Elastic shear modulus k_S	5.3×10^{-6} Nm ⁻¹ [47]
Elastic dilatational modulus k_α	$50 k_s$ [1]
Bending modulus k_B	2×10^{-19} Nm [38]
Plasma viscosity μ_{out}	1.2×10^{-3} Pa s [1]
Cytoplasm viscosity μ_{in}	6×10^{-3} Pa s [1]

FIG. 5: 3D triangular mesh used to represent the viscoelastic membrane of the RBC: the elastic behaviour is described by the Skalak model, while the Standard Linear Solid Model (SLS) is used to take into account the membrane viscosity (see Sec. II B). The table on the right summarises the physical dimensions, the elastic parameters and the adapted transport coefficients.

IV. RESULTS ON RED BLOOD CELLS (RBCS)

RBC membrane comprises a cytoskeleton and a lipid bilayer, tethered together, forming a 2D thin shell [38, 54], characterised by a thickness of about three orders of magnitude smaller than the diameter. We recreate such a structure via a 3D triangular mesh with $N_f \approx 4000$ faces, as depicted in Fig. 5. To reconstruct it, we have employed the shape equation parametrised by [55]:

$$z(x, y) = \pm \sqrt{1 - \frac{x^2 + y^2}{r^2}} \left(C_0 + C_1 \frac{x^2 + y^2}{r^2} + C_2 \left(\frac{x^2 + y^2}{r^2} \right)^2 \right) \quad (21)$$

with $C_0 = 0.81 \times 10^{-6}$ m, $C_1 = 7.83 \times 10^{-6}$ m and $C_2 = -4.39 \times 10^{-6}$ m; $r = 3.91 \times 10^{-6}$ m is the large radius (see Fig. 5). Regarding the elastic moduli (see Sec. II B), we use the bending modulus $k_B = 2 \times 10^{-19}$ Nm [38], the elastic shear modulus $k_S = 5.3 \times 10^{-6}$ Nm⁻¹ [47] and the elastic dilatational modulus $k_\alpha = 50k_S$ [1]. We chose the values of the elastic moduli in order to reproduce the dynamics of a young and healthy RBC: older erythrocytes are characterised by larger values of the shear modulus (about 20%) [56]. Plasma viscosity is set to $\mu_{out} = 1.2 \times 10^{-3}$ Pa s,

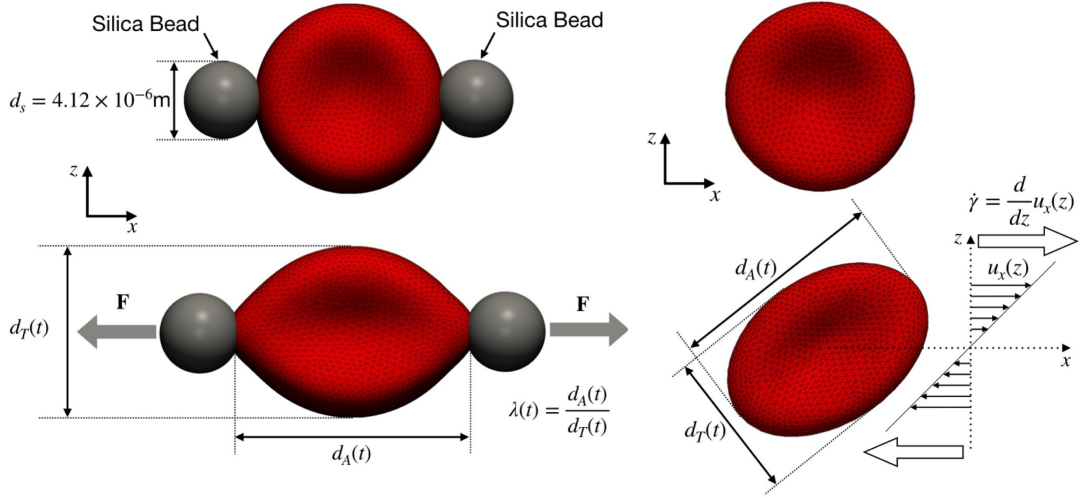

FIG. 6: Deformation of a single RBC under an external mechanical load. Left panel: stretching caused by 2 forces with the same intensity F and opposite direction, applied at the ends of the erythrocyte. Forces are applied on a selected number of nodes (see text for details), in order to mimic the experimental stretching of the RBC induced by two silica beads bonded to the cell ends in an optical tweezer [47]. The RBC deformation is quantified with the extension ratio $\lambda(t) = d_A(t)/d_T(t)$, where $d_A(t)$ and $d_T(t)$ are the axial and transversal diameters, respectively. Right panel: sketch of the deformation of the RBC in a linear shear flow.

while the cytoplasm viscosity is $\mu_{in} = 6 \times 10^{-3}$ Pa s [1]. All the aforementioned details are summarised in Fig. 5. Considering the membrane viscosity, we put $\mu_s = \mu_d = \mu_m$ [53], with the membrane viscosity varying in the range $\mu_m \in [0, 3.18 \times 10^{-7}]$ m Pa s (note that μ_m is the viscosity of the 2D membrane and therefore it is measured in [m Pa s]). The value of the artificial spring in the SLS model is $k' = \frac{100}{3}k_S$ (see Sec. II B). We wish to stress that we directly use μ_m instead of Bq to quantify the effects of membrane viscosity: in fact, since the RBC at rest is not spherical, the Boussinesq number (see Eq. (18)) is no more univocally defined, i.e. it is not clear which length scale should be considered (e.g. the main radius, the radius of a sphere having the same surface area of the RBC, etc...). The same ambiguity arises considering the Capillary number (see Eq. (13)): therefore, instead of using Ca to quantify the shear flow, we prefer to consider the shear rate. The latter is changed in the range $\dot{\gamma} \in [1.23, 123]$ s $^{-1}$. Just to give an idea on what would be the corresponding Bq and Ca for a particular realisation of the length scale: if we choose the main radius $r = 3.91 \times 10^{-6}$ m as characteristic length scale, we obtain $Bq = \frac{\mu_m}{\mu_{out}r} \in [0, 50]$ and $Ca = \dot{\gamma} \frac{\mu_{out}r}{k_S} \in [0.01, 0.10]$. To study the transient dynamics of the RBC, we characterised the relaxation time t_c following the sudden arrest of an external mechanical load [26, 57–61]. Going back to the general motivations that we have exposed in Section I, we stress once more that the characterisation of such a relaxation time provides important insights on the choice of the parameters in the so-called “tensor based” hemolysis models for VADs design and improvement [14, 16–18]. In such models, the RBC is described via a reduced model comprising the competing actions of elastic forces, which tend to relax the cell to its original shape, and drag forces, which tend to deform the RBC. Understanding the precise dependency of the relaxation time on the degree of initial deformation for realistic values of membrane viscosity is definitively important for novel applications in the large scale numerical simulation of blood flows within VADs. Starting from the steady, deformed erythrocyte configurations, we have characterised the shape recovery by suddenly switching off the external mechanical load and by monitoring the extension ratio $\lambda(t) = d_A(t)/d_T(t)$, where $d_A(t)$ and $d_T(t)$ are the axial and transverse diameters, respectively (see Fig. 6). We then constructed the time-dependent elongational index [57, 62]

$$\Lambda(t) = \frac{[\lambda(t) - \lambda_{fin}][\lambda_{in} + \lambda_{fin}]}{[\lambda(t) + \lambda_{fin}][\lambda_{in} - \lambda_{fin}]} \quad (22)$$

where λ_{in} and λ_{fin} correspond to the values of the extension ratio at the beginning and the end of the relaxation process, respectively. The elongational index is constructed in such a way that it has an initial value of 1 and tends to 0 when the original shape is recovered. The relaxation time t_c is then obtained via a fit through the stretched exponential

$$\Lambda(t) = \exp \left\{ - \left(\frac{t}{t_c} \right)^\delta \right\} \quad (23)$$

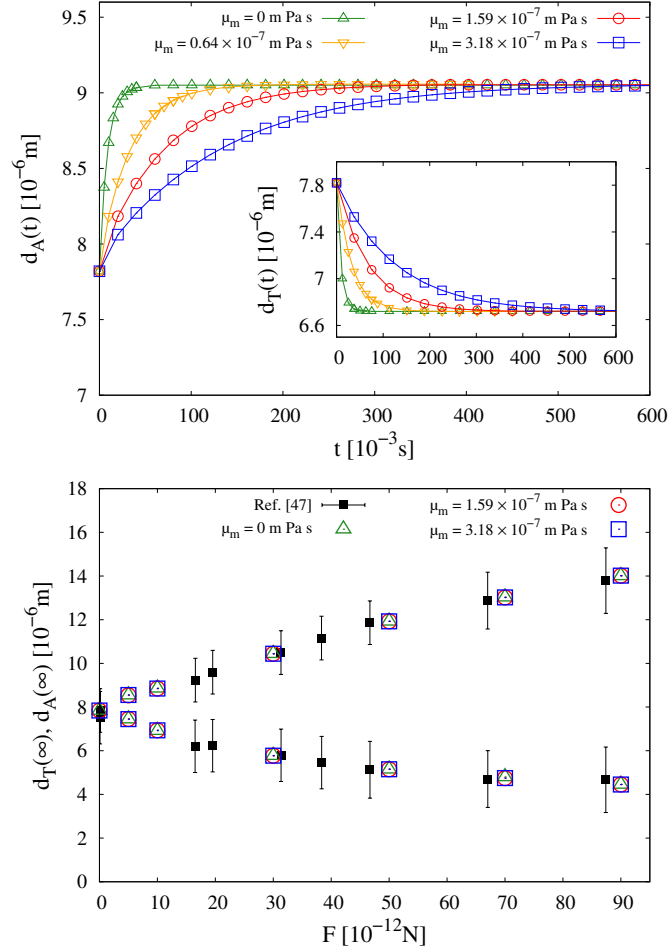

FIG. 7: Results for the stretching experiment of a single RBC with $F = 5 \times 10^{-12}$ N (cfr. Fig. 6). Top panel: we report the axial ($d_A(t)$) and transversal ($d_T(t)$) diameters as a function of time t for a given force $F = 5 \times 10^{-12}$ N and different values of the membrane viscosity μ_m . Lines are guides for the eyes. Bottom panel: steady state values of the axial and transversal diameters as functions of the intensity of the applied force F for different values of membrane viscosity μ_m . Experimental data are also reported [47]. A similar analysis for the RBC deformed in linear shear flow is presented in Fig. 10.

where δ is a free parameter close to 1 that is used to best fit the data [57].

In the following, we show the numerical results on the deformation and the shape recovery of a single RBC deformed by an external mechanical load. In Sec. IV A, we numerically study the RBC deformation caused by two forces applied at the RBC ends, a set-up that is meant to mimic the deformation of RBC experimentally observed in optical tweezers [47]. In Sec. IV B we study the RBC deformation and shape recovery under the imposition of a given shear rate. In Sec. IV C we will compare the results from both protocols. The membrane viscosity μ_m and the load strength will be kept as variable input parameters.

A. Stretching

We simulate the stretching of a single erythrocyte induced by two constant forces of equal intensity $F = |\mathbf{F}|$ and opposite direction, applied at the ends of the RBC (see Fig. 6, left panel). Simulations are performed in a 3D box $L_x \times L_y \times L_z = (28 \times 12 \times 12) \times 10^{-6}$ m, with full periodic boundary conditions along all directions; we study the cell deformation by varying both the membrane viscosity μ_m and forcing intensity F . The set-up that we use is meant to mimic the stretching experiments conducted on a single RBC in an optical tweezer, wherein two silica beads (whose diameter is $d_s = 4.12 \times 10^{-6}$ m) are attached to the two ends of the erythrocyte [47]. In the simulations, we consider two areas at the end of the membrane which are compatible with the dimensions of the silica beads used in the experiments [47], and we apply a force $\tilde{\mathbf{F}} = \mathbf{F}/n_s$ at each of the n_s nodes that lie in this area. Notice

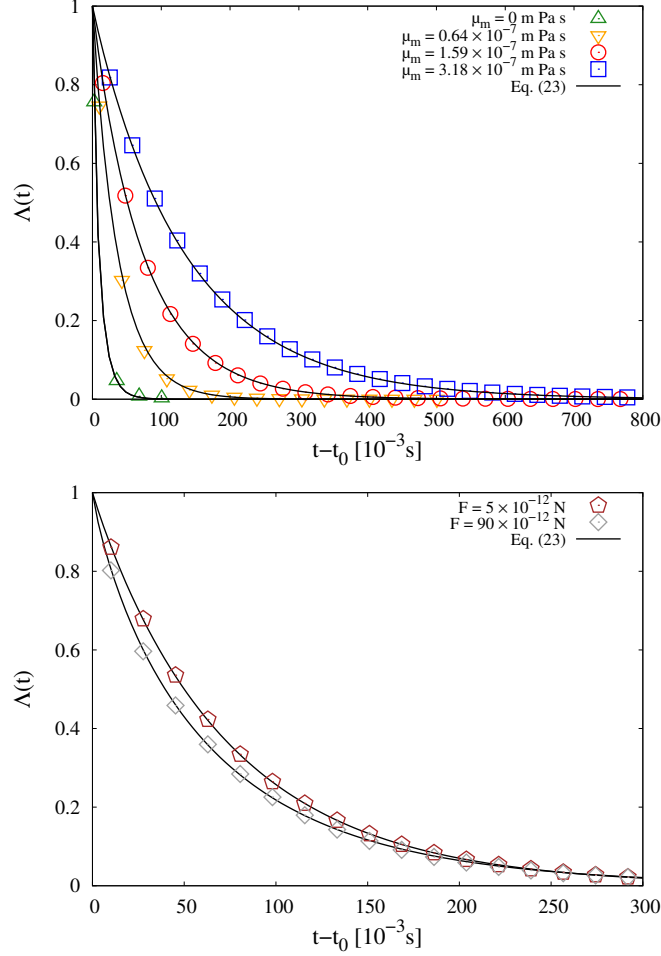

FIG. 8: RBC membrane relaxation after the sudden arrest of the mechanical load of intensity F . Top panel: we report the elongational index (cfr. Eq. (22)) as a function of time for a fixed $F = 5 \times 10^{-12}$ N and different values of membrane viscosity μ_m . Bottom panel: we report the elongational index as a function of time for a fixed value of membrane viscosity $\mu_m = 1.59 \times 10^{-7}$ m Pa s and different forces F . In both cases, the simulation data are fitted with a stretched exponential function (cfr. Eq. (23)) from which we compute the relaxation time t_c . A similar analysis for the RBC deformed in linear shear flow is presented in Fig. 11.

that previous numerical studies with the IB-LBM by Krüger *et al.* [32] already investigated the deformation of a single RBC under the set-up that we use. Here we want to further extend such a study by highlighting the role of membrane viscosity. In the top panel of Fig. 7, we show the transient dynamics of both $d_A(t)$ and $d_T(t)$ in the presence of a force intensity $F = 5 \times 10^{-12}$ N, for different values of μ_m . We observe that the membrane viscosity plays a paramount role in the approach towards the steady state (in fact, a larger μ_m corresponds to larger time needed to reach the steady state), while it does not affect the value of such a steady state deformation (bottom panel). This is quite apparent, in view of the fact that there is no stationary flow for large times, hence dissipation on the membrane does not take place. Results on the relaxation time are reported in Fig. 8. In the top panel, we report the time evolution of the elongational index $\Lambda(t)$ (see Eq. (22)) after the arrest of an applied forcing $F = 5 \times 10^{-12}$ N, for different values of μ_m . We chose $F = 5 \times 10^{-12}$ N (that is the smallest force that we simulated) because we expect that forcing effects are negligible for such a low value of F , hence the analysis highlights the intrinsic properties of the viscoelastic membrane. Again, the increase of μ_m results in slower recovery dynamics. We further studied the dependency of the relaxation time on the applied forcing strength. Results are reported in the bottom panel of Fig. 8. Again, we plot the evolution of the elongational index $\Lambda(t)$, but now we fix the membrane viscosity $\mu_m = 1.59 \times 10^{-7}$ m Pa s and we vary the force strength F by an order of magnitude. Larger forcing (i.e. more deformed shape) results in faster recovery dynamics. In both cases, we observe that Eq. (23) provides an excellent fit to the data. Thus, the relaxation time t_c can be accurately retrieved: the values of t_c as a function of F for different values of membrane viscosity μ_m are reported in Fig. 9, highlighting that the relaxation time changes at least of a

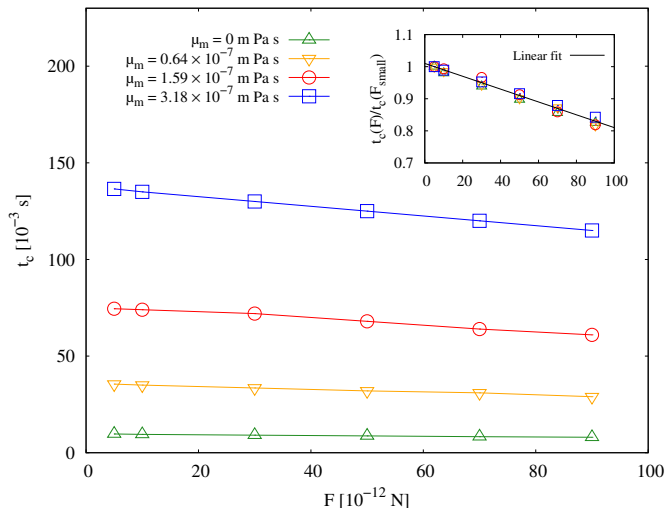

FIG. 9: RBC membrane relaxation after the sudden arrest of the mechanical load of intensity F . We report the relaxation time t_c as a function of the forcing F , for different values of membrane viscosity μ_m ; lines are guides for the eyes. The inset shows normalised data with respect to the relaxation time at the smallest forcing analysed. Linear fit to the data is also provided (see text for details).

Author	t_c [s]	μ_m [10^{-7} m Pa s]	Technique
Evans & Hochmuth 1976 [26]	0.300	~ 1	Micropipette aspiration
Chien <i>et al.</i> 1978 [58]	0.146 ± 0.055	0.6 - 4.0	Micropipette aspiration
Hochmuth <i>et al.</i> 1979 [20]	0.100 - 0.130	6 - 8	Micropipette aspiration
Tran-Son-Tay <i>et al.</i> 1984 [60]	-	0.53 - 0.96	Tank-treading
Baskurt & Meiselman 1996 [21]	0.119 ± 0.017	-	Shear (light reflection)
Baskurt & Meiselman 1996 [21]	0.097 ± 0.015	-	Shear (ektacytometry)
Riquelme <i>et al.</i> 2000 [61]	-	2.7 - 4.1	Sinusoidal shear stress
Tomaiuolo & Guido 2011 [23]	0.100	4.7 - 10.0	Microchannel Deformation
Braunmüller <i>et al.</i> 2012 [59]	0.100 - 0.130	~ 10	Micropipette aspiration
Prado <i>et al.</i> 2015 [24]	0.08 ± 0.01	0.6 - 0.9	Numerical and experimental
Fedosov 2010[57]	0.100 - 0.130	$\sim 1^\dagger$	Numerical simulation
This work	0.100 - 0.140	~ 3.18	Numerical simulation

TABLE I: Experimental and numerical relaxation times.

† Fedosov reports the 3D membrane viscosity $\mu_m^{3D} = 0.022$ Pa s. We multiplied this values by the radius of the RBC to get μ_m .

factor 15-20 % when the forcing increases. More quantitatively, for a given value of μ_m , we have analysed data by rescaling the relaxation time with the value corresponding to the smallest forcing available, i.e. $F_{\text{small}} = 5 \times 10^{-12}$ N : results are displayed in the inset of Fig. 9. Remarkably, data for different μ_m collapse together on a master curve, that we linearly fit with $t_c(F)/t_c(F_{\text{small}}) = a_0 - a_1 F$, with $a_0 = 1.01$ and $a_1 = 2 \times 10^9$ N $^{-1}$. This collapse shows that the functional dependency on the forcing can be factorised with respect to the dependency on the membrane viscosity.

B. Linear shear flow

We simulate the deformation of a single RBC induced by an imposed shear with intensity $\dot{\gamma}$ (that is the same setup used in benchmark section, see Sec. III). This load mechanism differs from the stretching force considered in the previous section, hence we can investigate the dependency of the relaxation time on the typology of the mechanical load. Simulations are performed in a 3D box $L_x \times L_y \times L_z = (20 \times 20 \times 32) \times 10^{-6}$ m with periodic boundary conditions set along x and y directions. As for the droplet and spherical capsule case (cfr. Sec. III), we set the wall velocity $U_w = (\pm \dot{\gamma} L_z / 2, 0, 0)$ on the two plane walls at $z = \pm L_z / 2$ ($U_w > 0$ for $z > 0$), while periodic boundary conditions are set along x and y directions. The orientation of the RBC with respect to the shear flow is shown in Fig. 6. In general,

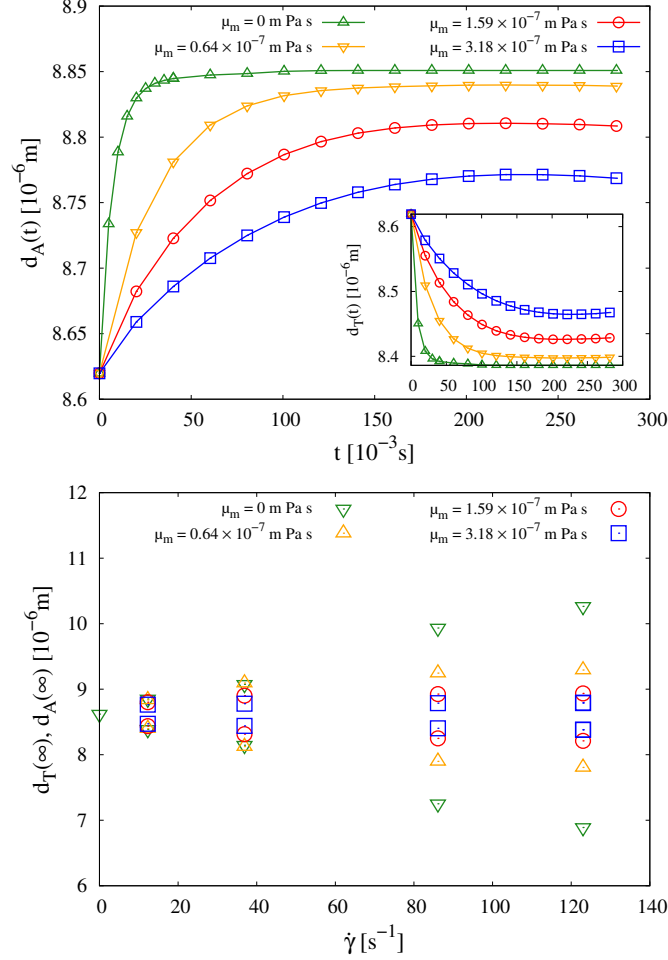

FIG. 10: Results for the deformation of a single RBC in linear shear flow with intensity $\dot{\gamma}$ (cfr. Fig. 6). Top panel: we report the axial ($d_A(t)$) and transversal ($d_T(t)$) diameters as a function of time t for a given shear rate $\dot{\gamma} = 1.23s^{-1}$ and different values of the membrane viscosity μ_m . Lines are guides for the eyes. Bottom panel: steady state values of the axial and transversal diameters as functions of the intensity of the applied shear rate $\dot{\gamma}$ for different values of μ_m .

non-symmetric capsules (such as a RBC) have chaotic tumbling dynamics in shear flows, which would complicate our study. Since we are interested in studying an alternative mechanical load to be compared with the stretching experiment in optical tweezers, we chose the simplest set-up: we place the major axial diameters of the RBC in the shear plane in order to avoid complications coming from the emergence of tumbling motion [63]. The 3D mesh used to represent the RBC is the same used in the stretching experiment. Now, we vary both the membrane viscosity μ_m and the intensity of shear rate $\dot{\gamma}$. Similarly to what we have done for the stretching experiment (see Fig. 7), we first look at the dynamics of the deformation of the RBC under a linear shear flow and at the steady state shape. In the top panel of Fig. 10, we plot the transient dynamics of main diameters $d_A(t)$ and $d_T(t)$. Similarly to the stretching experiment, we found a slower dynamics when the membrane viscosity μ_m increases; on the other hand, unlike the stretching experiment, the steady deformation is now affected by the membrane viscosity because the steady states have a non zero velocity acting on the surface of the RBC. The results on the steady state deformation are reported in the bottom panel of Fig. 10. Increasing the membrane viscosity results in a smaller deformation, which is in line with what we found in Section III A (see Fig. 2). Moreover, for the largest $\dot{\gamma}$ analysed, we noticed that the dynamics of the elongational index shows oscillations around a mean value when approaching the steady state (data not shown), similarly to what happens for a viscous capsule (see Fig. 4). For a fixed shear rate $\dot{\gamma}$ and membrane viscosity μ_m , these oscillations go to zero in time. Again, to further investigate the transient dynamics of the RBC after the arrest of the shear flow, we look at the time-dependent elongational index $\Lambda(t)$ (Eq. (22)) and we use Eq. (23) to fit our data. In the top panel of Fig. 11, we report the time evolution of $\Lambda(t)$ with constant shear rate $\dot{\gamma} = 0.64 \times 10^{-7} s^{-1}$ for different values of membrane viscosity μ_m . As already observed in the stretching experiment (see Fig. 8), increasing the membrane viscosity μ_m results in a slower recovery dynamics. In the bottom panel of Fig. 11, we study the effect

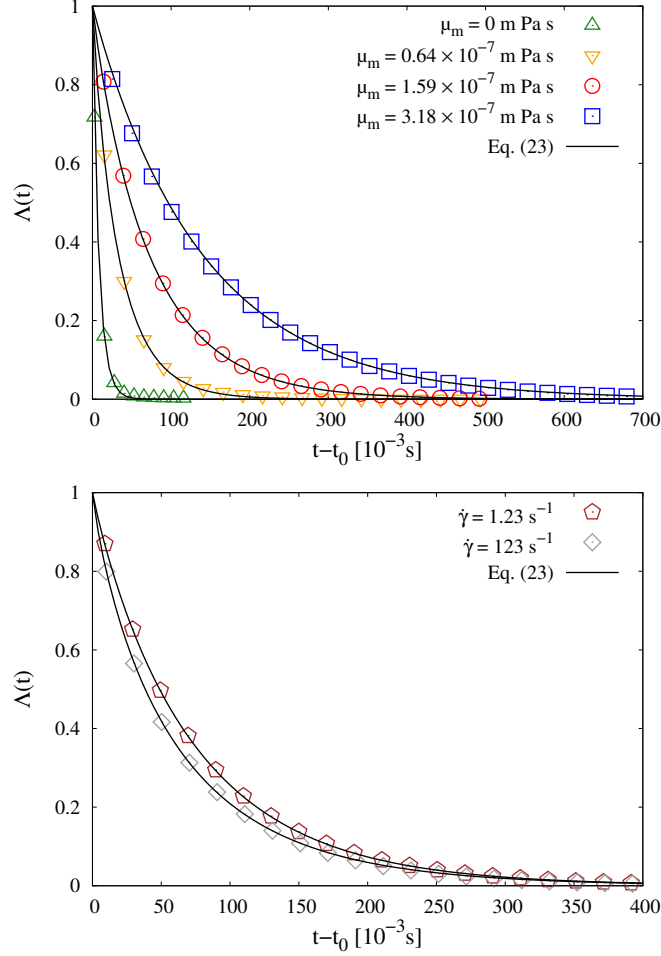

FIG. 11: RBC membrane relaxation after the sudden arrest of the shear flow of intensity $\dot{\gamma} = 1.23 \text{ s}^{-1}$. Top panel: we report the elongational index (cfr. Eq. (22)) as a function of time for a fixed $\dot{\gamma} = 1.23 \text{ s}^{-1}$ and different values of membrane viscosity μ_m . Bottom panel: we report the elongational index as a function of time for a fixed value of membrane viscosity $\mu_m = 1.59 \times 10^{-7} \text{ m Pa s}$ and different shear rates $\dot{\gamma}$. In both cases, the simulation data are fitted with a stretched exponential function (cfr. Eq. (23)) from which we compute the relaxation time t_c .

of the shear rate $\dot{\gamma}$ for a fixed value of membrane viscosity $\mu_m = 1.59 \times 10^{-7} \text{ m Pa s}$. Again, a higher strength of the mechanical load (i.e. higher shear rate $\dot{\gamma}$) corresponds to a lower relaxation time. Finally, all the values of t_c that we extracted based on the Eq. (23) are reported in Fig. 12 for different values of $\dot{\gamma}$ and μ_m . At difference with respect to the stretching experiment, we notice that for fixed membrane viscosity the relation between t_c and $\dot{\gamma}$ does not show a net linear behaviour; rather, for the largest μ_m we observe the emergence of some non-linear behaviour which is steeper at smaller $\dot{\gamma}$. Some important additional information is also conveyed by the inset in Fig. 12, where we report data normalised with respect to the relaxation time at the smallest $\dot{\gamma}$ analysed, i.e. $\dot{\gamma}_{\text{small}} = 1.23 \text{ s}^{-1}$. We see that the dependence of the relaxation time on the shear rate is triggered by a non-zero membrane viscosity: while data at $\mu_m = 0$ do not show an appreciable shear rate-dependency, when $\mu_m > 0$ such dependency appears and is more pronounced at increasing μ_m .

C. Comparison between load mechanisms

Given the analysis for the relaxation times that we have performed in Secs. IV A-IV B, the natural next step is the quantitative comparison between the two load mechanisms. In order to make the comparison fair, we need to appropriately compare the strengths of the two load mechanisms. To do so, we decided to look at the total stress σ^T of the system in the initial configuration (prior to the relaxation process). The total stress can be split in two contributions, one coming from the particle (σ^P) and one from the fluid (σ^F) [1, 36]. In the stretching experiment

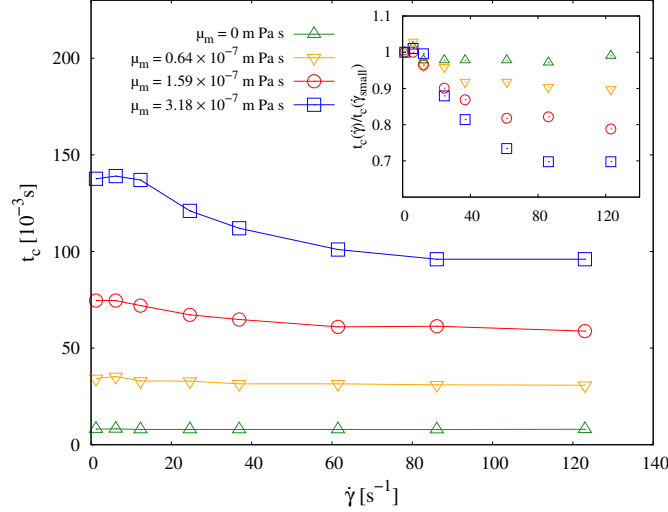

FIG. 12: RBC membrane relaxation after the sudden arrest of the shear flow of intensity $\dot{\gamma}$. We report the relaxation time t_c as a function of the shear rate $\dot{\gamma}$, for different values of membrane viscosity μ_m ; lines are guides for the eyes.

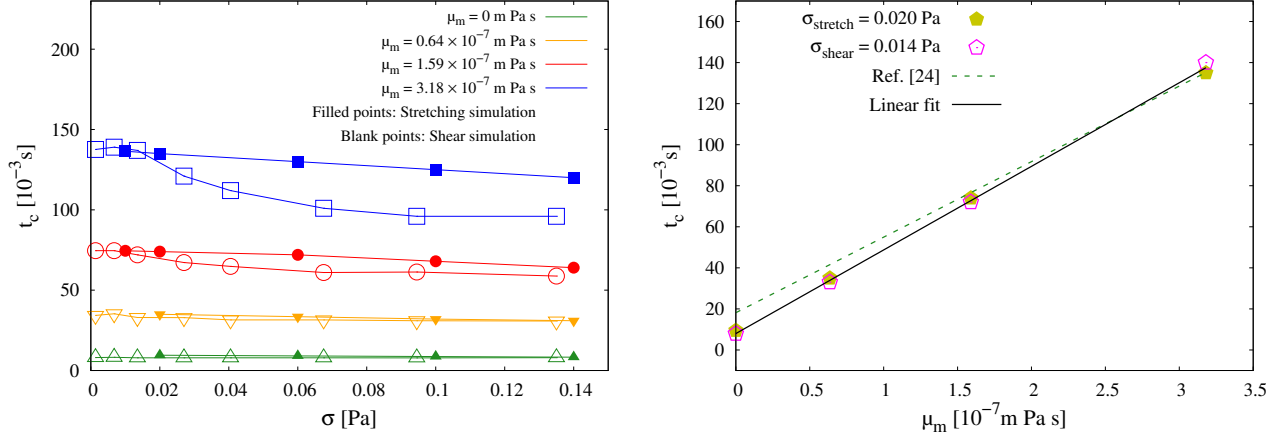

FIG. 13: Comparison between stretching (filled points) and shear (blank points) experiments. Left panel: we report the relaxation time t_c as a function of the mechanical load strength σ for different values of membrane viscosity. Details on the computation of the load strength are given in the text. Right panel: we show the relaxation time as a function of the membrane viscosity for small representative load strength simulated in both the stretching and shear experiment. Results are compared with the phenomenological estimate in [24]. Linear fit to the data is also provided.

there is no net flow, hence the particle stress contributes to the total stress; moreover, when we stretch the RBC with two opposite forces along the x axis, the main contribution to σ^p comes from σ_{xx}^p (the other diagonal components are smaller but not zero, $\sigma_{yy}^p \approx \sigma_{zz}^p < \sigma_{xx}^p$). In the shear experiment, instead, the major contribution to the total stress comes from the fluid part and the stress tensor is dominated by the off-diagonal xz -component, while diagonal components are non zero but smaller in magnitude. Given these facts, we decided to study the relaxation times as a function of the value of the dominant total stress contribution (hereafter load strength), i.e. σ_{xx}^T for the stretching experiment and σ_{xz}^T for the shear experiment. Results are reported in Fig. 13. In the Left panel, we report the results of Fig. 9 (filled points) and Fig. 12 (blank points) as a function of the corresponding load strength. Results do not overlap exactly, and this is not surprising, since the two load mechanisms are actually different in nature: while in the stretching experiment, the erythrocyte starts the relaxation process with the fluid at rest, in the shear experiment the RBC is immersed in a fluid flow with a given velocity profile. This reflects on the different stress contributions that we measure in the two cases: while in the stretching experiment the main stress component is related to the diagonal (xx) component, in the shear experiment the main contributions are off-diagonal (i.e. xz). Thus, it is not surprising that the results of the two simulations do not show a precise correspondence. Nevertheless, one has to

notice that, at fixed membrane viscosity, the two sets of data are somehow comparable in the order of magnitude. In other words, the value of the membrane viscosity sets the order of magnitude of the relaxation time, although the detailed functional dependency is affected by the chosen load mechanism. Independently of the load mechanism, however, one expects that when the load strength goes to zero the relaxation time should not depend on the chosen load mechanism: in such a limit, in fact, we should recover the membrane “intrinsic” relaxation time. This is indeed apparent from our data, as they show a neat asymptotic behaviour in the limit of vanishing load strength. Such a trend is better highlighted in the right panel of Fig. 13, in which we report the relaxation time t_c as a function of the membrane viscosity μ_m , both for the stretching and shear experiments, for the smallest values of simulated mechanical loads. This intrinsic relaxation time is in the order of few ms when μ_m goes to zero, which well agrees with the expectations in absence of membrane viscosity [64]; then, as μ_m increases, the intrinsic relaxation time linearly becomes of the order of hundreds of ms, which, again, is in good agreement with the values that can be retrieved from the experiments [20, 21, 23, 24, 58, 59] (see Tab. I). The linear fit $t_c = a_0 + a_1\mu_m$, with $a_0 = 10.08 \times 10^{-3}$ s and $a_1 = 0.395 \times 10^4$ m N⁻¹, well fits the data. We also plot the linear prediction by Prado *et al.* [24] which differs by roughly 10% by our best fit.

V. CONCLUSIONS

Computational Fluid Dynamics (CFD) is widely used to achieve optimal design of biomedical equipments, such as Ventricular Assist Devices (VADs) [5–13]. Blood circulation in these mechanical pumps is simulated via a multi-scale approach involving transient dynamics of red blood cells (RBCs) at mesoscales [14]. The quantitative information on such transient dynamics is typically retrieved from experiments, which obviously do not adapt to the variety of conditions which may be encountered in the pump. In this paper, we have taken an alternative pathway, by using mesoscale simulations to quantitatively characterise ab-initio the transient mesoscale dynamics of erythrocytes. The focus has been put on the quantitative description of the relaxation time of a single RBC following the sudden arrest of an external mechanical load. Our simulations featured a hybrid Immersed Boundary-Lattice Boltzmann Method (IB-LBM) [1], further coupled with the Standard Linear Solid model (SLS) [39] to account for the RBC membrane viscosity. Two load mechanisms have been considered: RBC stretching by means of an external force applied at the ends of the erythrocyte (stretching experiment) and the hydrodynamic deformation induced by a given external shear (shear experiment). The relaxation time of the RBC membrane has been quantitatively characterised as a function of the magnitude of the mechanical load, while keeping the membrane viscosity as an input parameter. In the limit case of vanishing load strengths, the relaxation time is a linear function of the membrane viscosity and does not sensibly depend on the load mechanism: in such a limit, in fact, the intrinsic relaxation time of the membrane is recovered. For finite load strength magnitudes, however, the relaxation time proves to depend non trivially on the load strength. More specifically, considering realistic RBC relaxation times corresponding to a membrane viscosity in the range $\mu_m \in [1.59, 3.18] \times 10^{-7}$ m Pa s, results of numerical simulations show that for the stretching experiment the relaxation time decreases linearly with the load strength, while for the shear experiment it decreases with a non-linear behaviour. Overall, one could fairly conclude that while the order of magnitude of the relaxation time is set by the value of the membrane viscosity, its detailed functional dependency on the load strength is closely related to the typology of the load mechanism. Importantly, thanks to systematic investigations like those that we proposed in this study, such dependencies can be studied and quantified.

In view of the above findings, interesting future perspectives can be envisaged. Shear rates in VADs show a spatial modulation [15], hence the natural choice for a CFD model of VAD circulation would be that of a flow-dependent relaxation time. Our mesoscale simulations offer the possibility to “tune” such flow-dependency in a realistic way. Whether or not this spatial dependency may cause a sensible change in the predictions of the VAD performance definitively warrants future investigations. More generally, it would be definitively of interest to study the time response of RBCs to a “generic” time dependent strain rate, which reproduces the main features of fluids (Reynolds numbers, frequency spectrum, etc etc) of those encountered in biomedical devices.

Acknowledgments

The authors acknowledge fruitful discussions with G. Koutsou, T. Krüger, S. Gekle, M. De Tullio, P. Decuzzi and P. Lenarda. This project has received funding from the European Union’s Horizon 2020 research and innovation programme under the Marie Skłodowska-Curie grant agreement No 765048. We also acknowledge support from the project “Detailed Simulation Of Red blood Cell Dynamics accounting for memBRane viscoElastic properties” (SorCeReS, CUP N. E84I19002470005) financed by the University of Rome “Tor Vergata” (“Beyond Borders 2019” call).

-
- [1] T. Krüger, *Computer Simulations Study of Collective Phenomena in Dense Suspensions of Red Blood Cells under Shear*. PhD thesis, 2012.
 - [2] L. Mountrakis *et al.*, *Transport of blood cells studied with fully resolved models*. 9789462597754, 2015.
 - [3] G. Falcucci, M. Lauricella, P. Decuzzi, S. Melchionna, S. Succi, *et al.*, “Simulating blood rheology across scales: A hybrid lb-particle approach,” *International Journal of Modern Physics C (IJMPC)*, vol. 30, no. 10, pp. 1–16, 2019.
 - [4] J. Mills, L. Qie, M. Dao, C. Lim, S. Suresh, *et al.*, “Nonlinear elastic and viscoelastic deformation of the human red blood cell with optical tweezers,” *MCB-TECH SCIENCE PRESS-*, vol. 1, pp. 169–180, 2004.
 - [5] M. Behbahani, M. BEHR, M. HORMES, U. Steinseifer, D. Arora, O. CORONADO, and M. Pasquali, “A review of computational fluid dynamics analysis of blood pumps,” *European Journal of Applied Mathematics*, vol. 20, pp. 363 – 397, 08 2009.
 - [6] T. Murakami, L. R. Golding, G. B. Jacobs, S. Takatani, R. Sukalac, H. Harasaki, and Y. NONE, “Nonpulsatile biventricular bypass using centrifugal blood pumps,” *Jinko Zoki*, vol. 8, no. 6, pp. 636–639, 1979.
 - [7] K. Nonaka, J. Linneweber, S. Ichikawa, M. Yoshikawa, S. Kawahito, M. Mikami, T. Motomura, H. Ishitoya, I. Nishimura, D. Oestmann, *et al.*, “Development of the baylor gyro permanently implantable centrifugal blood pump as a biventricular assist device,” *Artificial Organs*, vol. 25, no. 9, pp. 675–682, 2001.
 - [8] J. B. Anderson, H. G. Wood, P. E. Allaire, G. Bearnson, and P. Khanwilkar, “Computational flow study of the continuous flow ventricular assist device, prototype number 3 blood pump,” *Artificial Organs*, vol. 24, no. 5, pp. 377–385, 2000.
 - [9] Y. Miyazoe, T. Sawairi, K. Ito, Y. Konishi, T. Yamane, M. Nishida, T. Masuzawa, K. Takiura, and Y. Taenaka, “Computational fluid dynamic analyses to establish design process of centrifugal blood pumps,” *Artificial Organs*, vol. 22, no. 5, pp. 381–385, 1998.
 - [10] S. Yu, B. Ng, W. Chan, and L. Chua, “The flow patterns within the passages of a centrifugal blood pump model,” *Medical engineering & physics*, vol. 22, pp. 381–93, 08 2000.
 - [11] Y. Qian and C. D. Bertram, “Computational fluid dynamics analysis of hydrodynamic bearings of the ventrassist rotary blood pump,” *Artificial Organs*, vol. 24, no. 6, pp. 488–491, 2000.
 - [12] P. E. Allaire, H. G. Wood, R. S. Awad, and D. B. Olsen, “Blood flow in a continuous flow ventricular assist device,” *Artificial Organs*, vol. 23, no. 8, pp. 769–773, 1999.
 - [13] G. Burgreen, J. Antaki, Z. Wu, and A. Holmes, “Computational fluid dynamics as a development tool for rotary blood pumps,” *Artificial organs*, vol. 25, pp. 336–40, 06 2001.
 - [14] D. Arora, M. Behr, and M. Pasquali, “A tensor-based measure for estimating blood damage.,” *Artificial organs*, vol. 28 11, pp. 1002–15, 2004.
 - [15] L. Pauli, *Stabilized Finite Element Methods for Computational Design of Blood-Handling Devices*. Verlag Dr. Hut, 2016.
 - [16] D. Arora, M. Behr, and M. Pasquali, “Hemolysis estimation in a centrifugal blood pump using a tensor-based measure,” *Artificial organs*, vol. 30, no. 7, pp. 539–547, 2006.
 - [17] L. Pauli, J. Nam, M. Pasquali, and M. Behr, “Transient stress-based and strain-based hemolysis estimation in a simplified blood pump,” *International journal for numerical methods in biomedical engineering*, vol. 29, no. 10, pp. 1148–1160, 2013.
 - [18] L. Gesenhues, L. Pauli, and M. Behr, “Strain-based blood damage estimation for computational design of ventricular assist devices,” *The International journal of artificial organs*, vol. 39, no. 4, pp. 166–170, 2016.
 - [19] S. Hénon, G. Lenormand, A. Richert, and F. Gallet, “A new determination of the shear modulus of the human erythrocyte membrane using optical tweezers,” *Biophysical Journal*, vol. 76, no. 2, pp. 1145 – 1151, 1999.
 - [20] R. Hochmuth, P. Worthy, and E. Evans, “Red cell extensional recovery and the determination of membrane viscosity,” *Biophysical journal*, vol. 26, pp. 101–14, 05 1979.
 - [21] O. Baskurt and H. Meiselman, “Determination of red blood cell shape recovery time constant in a couette system by the analysis of light reflectance and ektacytometry,” *Biorheology*, vol. 33, no. 6, pp. 489 – 503, 1996.
 - [22] P. Bronkhorst, G. Streekstra, J. Grimbergen, E. Nijhof, J. Sixma, and G. Brakenhoff, “A new method to study shape recovery of red blood cells using multiple optical trapping,” *Biophysical journal*, vol. 69, no. 5, pp. 1666–1673, 1995.
 - [23] G. Tomaiuolo and S. Guido, “Start-up shape dynamics of red blood cells in microcapillary flow,” *Microvascular research*, vol. 82, no. 1, pp. 35–41, 2011.
 - [24] G. Prado, A. Farutin, C. Misbah, and L. Bureau, “Viscoelastic transient of confined red blood cells,” *Biophysical journal*, vol. 108, no. 9, pp. 2126–2136, 2015.
 - [25] R. Tran-Son-Tay, S. Sutura, and P. Rao, “Determination of red blood cell membrane viscosity from rheoscopic observations

- of tank-treading motion,” *Biophysical journal*, vol. 46, no. 1, pp. 65–72, 1984.
- [26] E. Evans and R. Hochmuth, “Membrane viscoelasticity,” *Biophysical journal*, vol. 16, no. 1, pp. 1–11, 1976.
- [27] T. Krüger, M. Gross, D. Raabe, and F. Varnik, “Crossover from tumbling to tank-treading-like motion in dense simulated suspensions of red blood cells,” *Soft Matter*, vol. 9, no. 37, pp. 9008–9015, 2013.
- [28] D. A. Fedosov, B. Caswell, and G. E. Karniadakis, “A multiscale red blood cell model with accurate mechanics, rheology, and dynamics,” *Biophysical journal*, vol. 98, no. 10, pp. 2215–2225, 2010.
- [29] Y.-H. Tang, L. Lu, H. Li, C. Evangelinos, L. Grinberg, V. Sachdeva, and G. E. Karniadakis, “Openrbc: a fast simulator of red blood cells at protein resolution,” *Biophysical journal*, vol. 112, no. 10, pp. 2030–2037, 2017.
- [30] W. Pan, D. A. Fedosov, B. Caswell, and G. E. Karniadakis, “Predicting dynamics and rheology of blood flow: A comparative study of multiscale and low-dimensional models of red blood cells,” *Microvascular research*, vol. 82, no. 2, pp. 163–170, 2011.
- [31] D. A. Fedosov, B. Caswell, and G. E. Karniadakis, “Systematic coarse-graining of spectrin-level red blood cell models,” *Computer Methods in Applied Mechanics and Engineering*, vol. 199, no. 29-32, pp. 1937–1948, 2010.
- [32] T. Krüger, D. Holmes, and P. V. Coveney, “Deformability-based red blood cell separation in deterministic lateral displacement devices—a simulation study,” *Biomicrofluidics*, vol. 8, no. 5, p. 054114, 2014.
- [33] D. A. Fedosov, W. Pan, B. Caswell, G. Gompper, and G. E. Karniadakis, “Predicting human blood viscosity in silico,” *Proceedings of the National Academy of Sciences*, vol. 108, no. 29, pp. 11772–11777, 2011.
- [34] A. Guckenberger, A. Kihm, T. John, C. Wagner, and S. Gekle, “Numerical–experimental observation of shape bistability of red blood cells flowing in a microchannel,” *Soft Matter*, vol. 14, no. 11, pp. 2032–2043, 2018.
- [35] F. Janoschek, “Mesoscopic simulation of blood and general suspensions in flow,” 2013.
- [36] M. Gross, T. Krüger, and F. Varnik, “Rheology of dense suspensions of elastic capsules: normal stresses, yield stress, jamming and confinement effects,” *Soft matter*, vol. 10, no. 24, pp. 4360–4372, 2014.
- [37] R. Skalak, A. Tozeren, R. P. Zarda, and S. Chien, “Strain energy function of red blood cell membranes,” *Biophysical journal*, vol. 13, no. 3, pp. 245–264, 1973.
- [38] G. Gompper and M. Schick, *Soft Matter: Lipid Bilayers and Red Blood Cells*. Wiley-VCH, 2008.
- [39] P. Li and J. Zhang, “A finite difference method with subsampling for immersed boundary simulations of the capsule dynamics with viscoelastic membranes,” *International Journal for Numerical Methods in Biomedical Engineering*, vol. 35, no. 6, p. e3200, 2019. e3200 cnm.3200.
- [40] T. Krüger, F. Varnik, and D. Raabe, “Efficient and accurate simulations of deformable particles immersed in a fluid using a combined immersed boundary lattice boltzmann finite element method,” *Computers & Mathematics with Applications*, vol. 61, no. 12, pp. 3485 – 3505, 2011. Mesoscopic Methods for Engineering and Science — Proceedings of ICMMS-09.
- [41] T. Krüger, H. Kusumaatmaja, A. Kuzmin, O. Shardt, G. Silva, and E. M. Viggen, *The Lattice Boltzmann Method - Principles and Practice*. 10 2016.
- [42] S. Succi, *The lattice Boltzmann equation: for fluid dynamics and beyond*. Oxford university press, 2001.
- [43] Z. Guo, C. Zheng, and B. Shi, “Discrete lattice effects on the forcing term in the lattice boltzmann method,” *Phys. Rev. E*, vol. 65, p. 046308, Apr 2002.
- [44] S. Succi, *The lattice Boltzmann equation: for complex states of flowing matter*. Oxford University Press, 2018.
- [45] S. Frijters, T. Krüger, and J. Harting, “Parallelised hoshen–kopelman algorithm for lattice-boltzmann simulations,” *Computer Physics Communications*, vol. 189, pp. 92 – 98, 2015.
- [46] W. Helfrich, “Elastic properties of lipid bilayers: theory and possible experiments,” *Zeitschrift für Naturforschung. Teil C: Biochemie, Biophysik, Biologie, Virologie*, vol. 28, no. 11, pp. 693–703, 1973.
- [47] S. Suresh, J. Spatz, J. P. Mills, A. Micoulet, M. Dao, C. Lim, M. Beil, and T. Seufferlein, “Connections between single-cell biomechanics and human disease states: gastrointestinal cancer and malaria,” *Acta biomaterialia*, vol. 1, no. 1, pp. 15–30, 2005.
- [48] A. Yazdani and P. Bagchi, “Influence of membrane viscosity on capsule dynamics in shear flow,” *Journal of Fluid Mechanics*, vol. 718, p. 569–595, 2013.
- [49] E. A. López-Guerra and S. D. Solares, “Modeling viscoelasticity through spring–dashpot models in intermittent-contact atomic force microscopy,” *Beilstein Journal of Nanotechnology*, vol. 5, pp. 2149–2163, 2014.
- [50] S. Shrivastava and J. Tang, “Large deformation finite element analysis of non-linear viscoelastic membranes with reference to thermoforming,” *The Journal of Strain Analysis for Engineering Design*, vol. 28, no. 1, pp. 31–51, 1993.
- [51] R. W. Flumerfelt, “Effects of dynamic interfacial properties on drop deformation and orientation in shear and extensional flow fields,” *Journal of Colloid and Interface Science*, vol. 76, no. 2, pp. 330 – 349, 1980.
- [52] J. Gounley, G. Boedec, M. Jaeger, and M. Leonetti, “Influence of surface viscosity on droplets in shear flow,” *Journal of Fluid Mechanics*, vol. 791, p. 464–494, 2016.
- [53] D. Barthes-Biesel and J. Rallison, “The time-dependent deformation of a capsule freely suspended in a linear shear flow,” *Journal of Fluid Mechanics*, vol. 113, pp. 251–267, 1981.
- [54] H. Li and G. Lykotrafitis, “Erythrocyte membrane model with explicit description of the lipid bilayer and the spectrin network,” *Biophysical journal*, vol. 107, no. 3, pp. 642–653, 2014.
- [55] E. Evans and Y.-C. Fung, “Improved measurements of the erythrocyte geometry,” *Microvascular research*, vol. 4, no. 4, pp. 335–347, 1972.
- [56] P. Bronkhorst, G. Streekstra, J. Grimbergen, E. Nijhof, J. Sixma, and G. Brakenhoff, “A new method to study shape recovery of red blood cells using multiple optical trapping,” *Biophysical journal*, vol. 69, no. 5, pp. 1666–1673, 1995.
- [57] D. A. Fedosov, *Multiscale modeling of blood flow and soft matter*. Citeseer, 2010.
- [58] S. Chien, K. L. Sung, R. Skalak, S. Usami, and A. Tözeren, “Theoretical and experimental studies on viscoelastic properties

- of erythrocyte membrane,” *Biophysical Journal*, vol. 24, no. 2, pp. 463–487, 1978.
- [59] S. Braunmüller, L. Schmid, E. Sackmann, and T. Franke, “Hydrodynamic deformation reveals two coupled modes/time scales of red blood cell relaxation,” *Soft Matter*, vol. 8, no. 44, pp. 11240–11248, 2012.
- [60] R. Tran-Son-Tay, S. Suter, and P. Rao, “Determination of red blood cell membrane viscosity from rheoscopic observations of tank-treading motion,” *Biophysical journal*, vol. 46, no. 1, pp. 65–72, 1984.
- [61] B. D. Riquelme, J. R. Valverde, and R. J. Rasia, “Determination of the complex viscoelastic parameters of human red blood cells by laser diffractometry,” in *Optical Diagnostics of Biological Fluids V*, vol. 3923, pp. 132–140, International Society for Optics and Photonics, 2000.
- [62] R. M. Hochmuth, P. Worthy, and E. A. Evans, “Red cell extensional recovery and the determination of membrane viscosity,” *Biophysical journal*, vol. 26, no. 1, pp. 101–114, 1979.
- [63] D. Cordasco and P. Bagchi, “On the shape memory of red blood cells,” *Physics of Fluids*, vol. 29, no. 4, p. 041901, 2017.
- [64] E. A. Evans, “[1] structure and deformation properties of red blood cells: Concepts and quantitative methods,” in *Methods in enzymology*, vol. 173, pp. 3–35, Elsevier, 1989.