



## **Fusion Electricity**

A roadmap to the realisation of fusion energy



## 28 European countries signed an agreement to work on an energy source for the future:

EFDA provides the framework, JET, the Joint European Torus, is the shared experiment, fusion energy is the goal.



## Preface

**A long-term perspective on fusion is mandatory since Europe has a leading position in this field and major expectations have grown in other ITER parties on fusion as a sustainable and secure energy source. China, for example, is launching an aggressive programme aimed at fusion electricity production well before 2050. Europe can keep the pace only if it focuses its effort and pursues a pragmatic approach to fusion energy. With this objective EFDA has elaborated the present roadmap.**



ITER is the key facility in the roadmap: ITER construction is fostering industrial innovation on a number of enabling technologies. Its licensing, completion of construction and successful operation will be fundamental milestones towards the fusion power plant. Thus ITER success is the most important overarching objective of the programme.

Still, the realisation of fusion energy has to face a number of technical challenges. For all of them candidate solutions have been developed and the goal of the programme is now to demonstrate that they will also work at the scale of a reactor. Eight different roadmap missions have been defined and assessed. They will be addressed by universities, research laboratories and industries through a goal-oriented programme detailed here for the Horizon 2020 period. This effort cannot be pursued only at European level – all the opportunities from international collaborations need to be exploited.

According to the present roadmap, a demonstration fusion power plant (DEMO), producing net electricity for the grid at the level of a few hundred Megawatts is foreseen to start operation in the early 2040s. Following ITER, it will be the single step to a commercial fusion power plant.

Defining, designing, building and operating DEMO requires the direct involvement of industry in the fusion programme that in the coming decades will move from being science-driven, laboratory-based towards an industry-driven and technology-driven venture. This transition requires strengthening the available engineering resources, and has to be facilitated already during Horizon 2020 by specific measures in support of training and education.

The success of the roadmap relies on the assumption that adequate resources will be made available by the European Commission and the EURATOM Member States. Coherently with the pragmatic approach advocated here, resources will be focussed on few well-defined objectives. As a consequence, the amount of resources for the roadmap will not exceed the amount originally recommended by the Council for FP7 outside the ITER construction, with the vast majority of resources being devoted to the ITER preparation. This will ensure that Europe will fully benefit from the large investment in the ITER construction.

The roadmap will be a living document, reviewed regularly in response to the physics, technology and budgetary developments.

  
Francesco Romanelli  
EFDA Leader

---



## How this document has been prepared

At the beginning of 2012 the European Commission requested EFDA to prepare a technical roadmap to fusion electricity by 2050. Specific Terms of Reference were elaborated by the EFDA Steering Committee Chair <sup>a</sup>.

- *The roadmap to be developed should take into account the financial perspectives of Horizon 2020 according to the Commission proposal to ensure to have a roadmap that fits to the financial boundary conditions as baseline scenario. In addition a roadmap as recommended by the Independent Panel<sup>b</sup> (somewhere between scenario 1 and 2) should be developed.*
- *The starting point of the work should be the exercise performed by the High Level Working Group<sup>c</sup> taking into account the comments of the Independent Panel. The aim here is to develop a more detailed roadmap for Horizon 2020 together with a proposal for a breakdown into comprehensive work packages. Perspectives for the time after 2020 should be given (in less detail) as well.*
- *The EFDA Leader and his staff will make use of the necessary expertise in the fusion programme.*

The EFDA Leader set up a Working Group to organise the work and prepare the roadmap report. In parallel a *Group for the assessment of the EU R&D Programme on DEMO structural and high-heat flux materials* (MAG) had been set up by EFDA at the end of 2011, at the request of the Chair of CCE-FU<sup>d</sup>, to assess and report on the Materials R&D Programme required for the demonstration Fusion Power Plant. In order to ensure full coherence of the activities, the MAG Chair was invited to participate in the roadmap group. The members of the Working Group are listed on page 62.

The roadmap has been developed within a goal-oriented approach articulated in eight different Missions. For each Mission the critical aspects for reactor application, the risks and risk mitigation strategies, the level of readiness now and after ITER and the gaps in the programme have been examined with involvement of experts from the ITER International Organization, Fusion for Energy, EFDA Close Support Units and EFDA Associates. High-level work packages for the roadmap implementation have been prepared and the resources evaluated. For each Mission a technical annex has been produced with an attached Risk Register and list of Work Packages.

The Fusion Industry Innovation Forum has discussed and commented on the roadmap document and has given its detailed input on industrial involvement.

A workshop was held in Garching on 25-26 July 2012 to present the roadmap to the fusion scientific community and to receive feedback. On the basis of that feedback and the comments of the EFDA Science and Technology Advisory Committee (STAC) the roadmap has been finalised. The present document was adopted by the EFDA Steering Committee on 4 October 2012 as initial reference for the joint activities starting in Horizon 2020.

<sup>a</sup> See document EFDA(12) 51/7.1

<sup>b</sup> A. Wagner, H. Chang, J.M. Delbecq, M. T. Dominguez, L. Maiani, W. Dominik, R. Orbach, J. Wood "Strategic orientation of the EU Fusion Programme (with emphasis on Horizon 2020) - Report by an Independent Expert Group Review Panel of the European Commission" Ref Ares (2011) 1114818

<sup>c</sup> C. Cesarsky, Ph. Garderet, J. Sanchez, M. Q. Tran, C. Varandas, B. Vierkorn-Rudolph, S. Païdassi "Strategic orientation of the Fusion Programme - Report of a group of experts assisting the European Commission to elaborate a roadmap for the fusion programme in Horizon 2020 – the Framework Programme for Research and Innovation" CCE-FU 53/3c

<sup>d</sup> Consultative Committee for the EURATOM specific research and training programme in the field of nuclear energy (fusion)



# A roadmap to the realisation of fusion energy

## Table of content

- Executive summary
- 1. Introduction – Make fusion a credible energy option
- 2. ITER – the key facility of the roadmap
- 3. A pragmatic approach to fusion energy – Fully exploit the potential of innovation
- 4. The fusion challenges
- 5. How to face the challenges – The missions for the realisation of fusion
- 6. Roadmap outline and milestones
- 7. Training and education – Form “Generation ITER”
- 8. Breaking new frontiers – The need for basic research
- 9. Industrial involvement – From provider of high-tech components to driver of fusion development
- 10. Exploit the opportunities from international collaborations
- 11. A living document: roadmap reviews and decision points
- 12. Resources
- List of Annexes
- Acknowledgements
- Glossary
- Authors
- Roadmap Gantt chart



## Executive Summary

- **ITER is the key facility in the roadmap.**

ITER will break new ground in fusion science and the European laboratories should focus their effort on its exploitation. To ensure its success, the preparation of operation on JET and JT-60SA should be undertaken as main risk mitigation measures. Small and medium sized tokamaks, both in Europe and beyond, with proper capabilities, will play a role in specific work packages. No major gaps exist in the foreseen world programme concerning the possibilities to develop operation scenarios for ITER and DEMO. However, adequate enhancements of ITER and JT-60SA will have to be carried out in the period 2021-2030.
- **A solution for the heat exhaust in the fusion power plant is needed.**

A reliable solution to the problem of heat exhaust is probably the main challenge towards the realisation of magnetic confinement fusion. The risk exists that the baseline strategy pursued in ITER cannot be extrapolated to a fusion power plant. Hence, in parallel to the programme in support of the baseline strategy, an aggressive programme on alternative solutions for the divertor is necessary. Some concepts are already being tested at proof-of-principle level and their technical feasibility in a fusion power plant is being assessed. Since the extrapolation from proof-of-principle devices to ITER/DEMO based on modelling alone is considered too large, a dedicated test on specifically upgraded existing facilities or on a dedicated Divertor Tokamak Test (DTT) facility will be necessary.
- **A dedicated neutron source is needed for material development.**

Irradiation studies up to ~30 dpa with a fusion neutron spectrum are needed before the DEMO design can be finalised. While a full performance IFMIF would provide the ideal fusion neutron source, the schedule for demonstration of fusion electricity by 2050 requires the acceleration of material testing. By the end of FP7 the possibility of an early start to an IFMIF-like device with a reduced specification (e.g. an upgrade of the IFMIF EVEDA hardware) or a staged IFMIF programme should be assessed. A selection should be made early in Horizon 2020 of risk-mitigation materials for structural, plasma-facing and high-heat flux zones of the breeding blanket and divertor areas of DEMO, also seeking synergy with other advanced material programmes outside fusion.
- **The R&D to ensure tritium self-sufficiency should be strengthened.**

The leading role will be played by the ITER Test Blanket Module (TBM) programme. However, the DEMO blanket selection will be made taking into account the constraints on coolant and breeder arising from the choice of an efficient Balance of Plant. As a risk mitigation strategy it is seen as necessary to foresee the evaluation, and potentially, the development, in addition to the two TBM designs based on the use of helium as coolant, of parallel lines such as a water-cooled lithium lead design.
- **DEMO design will benefit largely from the experience that is being gained with the ITER construction.**

Modest targeted investments in integrated design and system development (magnets, heating and current drive, vacuum pumping system and remote handling), safety and analysis of cost minimisation strategies are expected in Horizon 2020. Substantial investments for the construction of medium and large prototypes are expected during the engineering design activity (2021-2030).



- **Industry must be involved early in the DEMO definition and design.**

The evolution of the programme requires that industry progressively shifts its role from that of provider of high-tech components to that of driver of fusion development. Industry must be able to take full responsibility for the commercial fusion power plant after successful DEMO operation. For this reason, DEMO cannot be defined and designed by research laboratories alone, but requires the full involvement of industry in all technological and systems aspects of the design. Industry involvement needs a policy to maintain industrial competence. An early launch of the DEMO engineering design after the completion of ITER would facilitate maintaining industrial competences.
- **The EU Stellarator programme should focus on the optimised HELIAS line.**

The stellarator is a possible long-term alternative to a tokamak Fusion Power Plant. In addition, it provides a support to the ITER physics programme. For Horizon 2020, the main priority should be the completion and start of scientific exploitation of W7-X with full exploitation under steady-state conditions achieved beyond 2020. If W7-X confirms the good properties of optimised stellarators, a next step HELIAS burning plasma experimental device will be required to address the specific dynamics of a stellarator burning plasma. The exact goal of such a device can be decided only after a proper assessment of the W7-X results.
- **Theory and modelling effort in plasma and material physics is crucial.**

Theory and modelling provide the capability of extrapolating the available physics results to ITER and a fusion power plant. This is crucial for the extrapolation of the core and edge plasma dynamics for both tokamaks and stellarators. Material computer modelling needs to play an increasing role in the development of fusion materials to guide and interpret fission irradiations using isotopic tailoring and to predict and interpret the fusion irradiations at low doses and hence to help guide and shape the mission of an 'early stage' to the IFMIF programme.
- **Europe should seek all the opportunities for international collaborations.**

Some of the ITER parties have a very aggressive programme in fusion and Europe can clearly benefit by the participation in the design, construction and operation of their facilities. Already the Broader Approach with Japan is a good example of a positive collaboration that can give further advantages on the time scale considered here.



# 1. Introduction – Make fusion a credible energy option

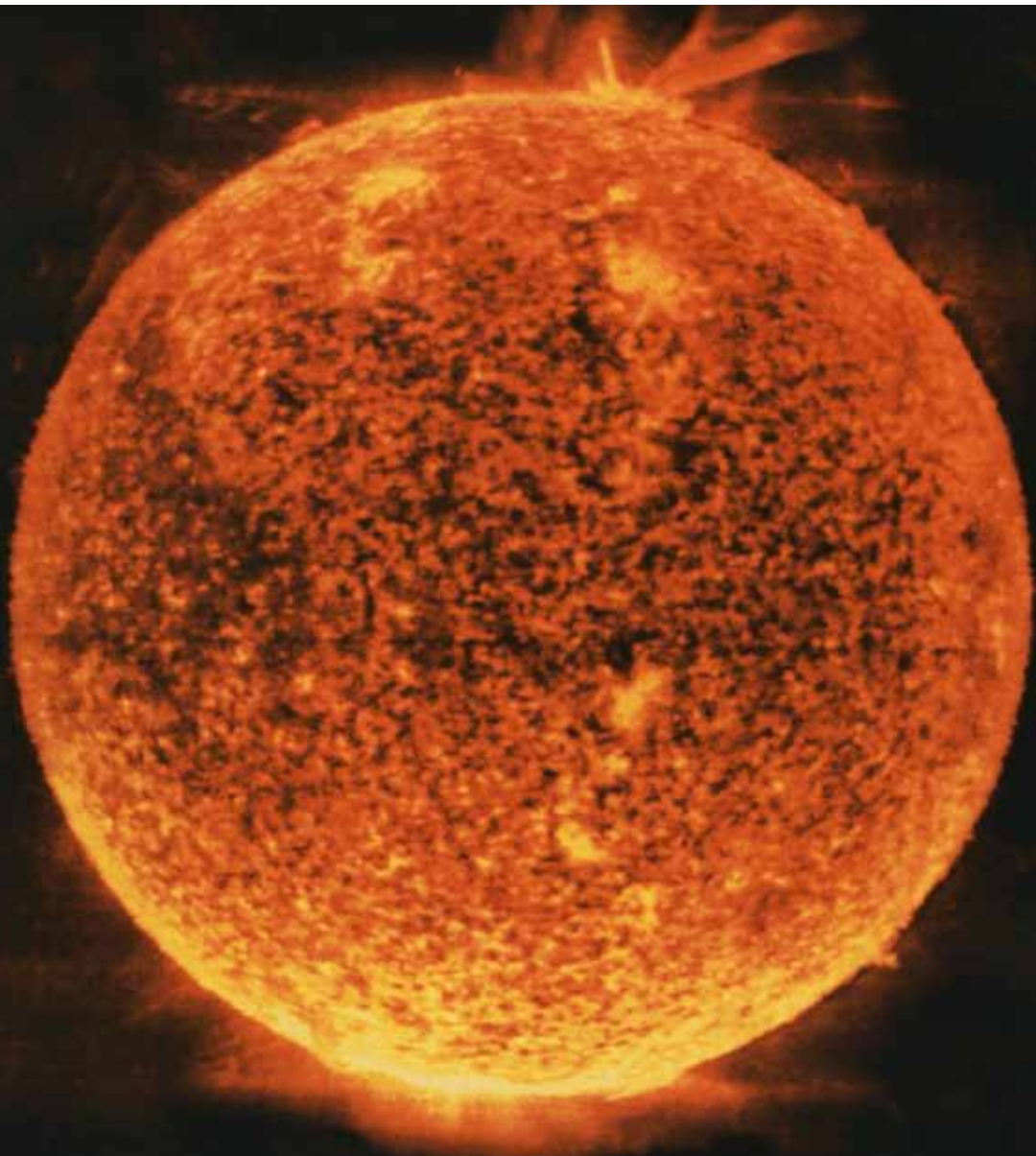

*Fusion energy is the energy of the stars*

Energy demand is expected to more than double by 2050 as the combined effect of the increases of population and energy consumption per capita in developing countries. Fossil fuels presently satisfy 80% of the primary energy demand but their impact on the environment through greenhouse gas emission is unacceptable. Energy sources that can prove their long-term sustainability and security of supply must replace fossil fuels.

The solution to the energy problem can come only by a portfolio of options that includes improvements in energy efficiency and (to degrees varying among countries) renewable energy, nuclear fission and carbon capture and sequestration. Fusion has advantages that ensure sustainability and security of supply: fuels are widely available and virtually unlimited; no production of greenhouse gases; intrinsically safe, as no chain-reaction is possible; environmentally responsible – with a proper choice of materials for the reaction chamber, radioactivity decays in a few tens of years and at around 100 years after the reactor shutdown all the materials can be recycled in a new reactor.

With the reduction of CO<sub>2</sub> emissions driving future energy policy, fusion can start market penetration around 2050 with up to 30% of electricity production<sup>1</sup> by 2100.

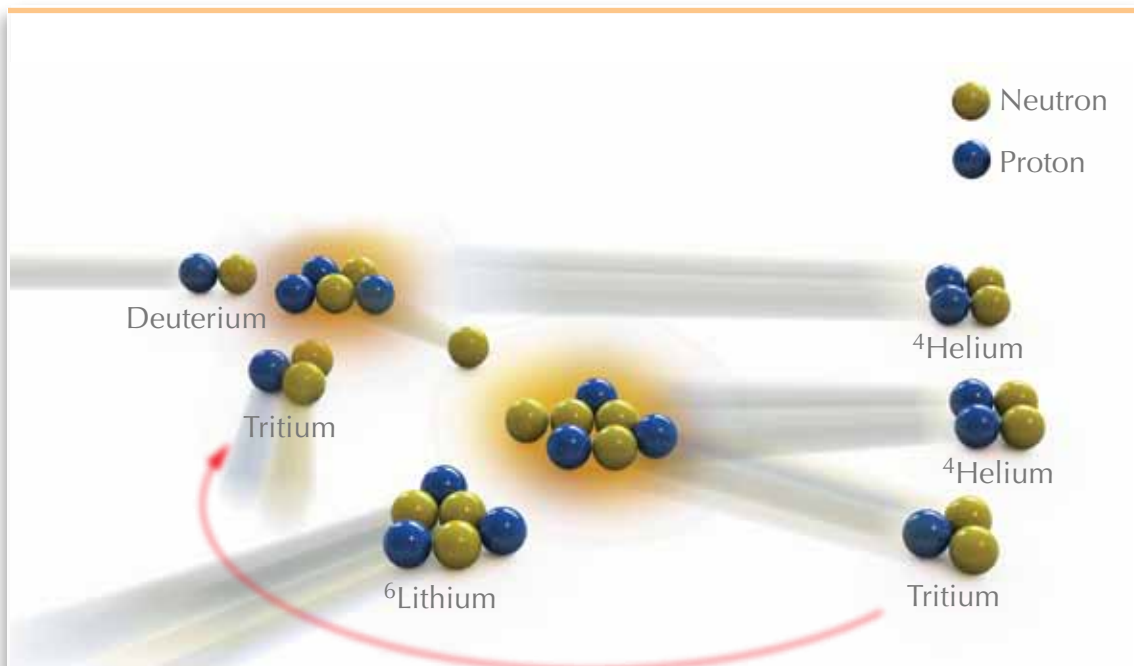

### Fusion: a virtually unlimited energy source

Fusion of light nuclei is the energy source that powers the sun. A fusion power plant utilises the fusion reaction between tritium and deuterium. The process yields a helium nucleus and a neutron, whose energy is harvested for electricity production. Deuterium is widely available, but tritium exists only in tiny quantities. The fusion reactor has to produce it via a reaction between the neutron and lithium. Lithium, again, is abundant in the Earth's crust and in sea water. The global deuterium and lithium resources can satisfy the world's energy demand for millions of years.

<sup>1</sup>Fusion is expected to contribute especially to base-load generation.

<sup>2</sup>Proposal for a COUNCIL DECISION establishing the Euratom Research and Training Programme (2014-2018) contributing to the implementation of the 'Horizon 2020' Framework Programme for Research and Innovation

<sup>3</sup>D. King et al. Conclusions of the Fusion Fast Track expert meeting 27 November 2001

## Confining hot fusion plasmas

Atomic nuclei are positively charged and repel each other. They only fuse if they collide fast enough to overcome the repelling force. As particle speed corresponds to temperature, the fusion fuels have to be heated to about 200 million °C, 20 times hotter than the core of the sun. At these temperatures, atoms dissolve into nuclei and electrons, forming a gas of charged particles called plasma. The hot fusion plasma must not touch the reactor wall, and it is therefore confined by means of magnetic fields. The technology of confining hot plasmas in a doughnut shaped chamber is routine in fusion experiments worldwide.

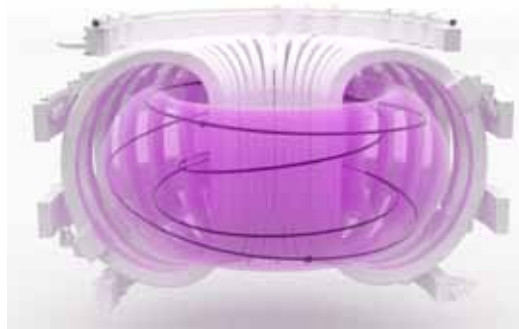

**This requires an ambitious, yet realistic roadmap towards the demonstration of electricity production by 2050<sup>2</sup>.**

Since the definition of the *Fast Track* approach to fusion energy<sup>3</sup> in 2001, the European fusion roadmap has been based on three elements:

- The ITER project as the “essential step towards energy production in a fast track”;
- A single step (DEMO) between ITER and the commercial fusion power plant designed “as a credible prototype for a power-producing fusion reactor, although in itself not fully technically or economically optimised”;
- The International Fusion Materials Irradiation Facility (IFMIF), for material qualification under intense neutron irradiation, in parallel with ITER

The role of these elements in the programme has been the subject of several reviews in the last five years:

- The SET plan<sup>4</sup>;
- The Facility Review in 2008<sup>5,6</sup>;
- The Working Group on JET and Accompanying Programme<sup>7</sup>;
- The Analysis of the Strategic Orientations of the Fusion Programme<sup>8,9</sup>; and
- The DEMO Working Group<sup>10</sup>.

The present document builds on the analysis carried out in the documents listed above but, in addition, makes an attempt to define a technically consistent programme aimed at electricity production from fusion by 2050. Specifically, the roadmap has been constructed in such a way that the only critical path is ITER, focussing on solutions that minimise the construction of large and complex test facilities and relying as far as possible on existing facilities and on access to the facilities of the international collaborators.

<sup>4</sup>COM (2007) 723 “Towards a European Strategic Technology Plan”

<sup>5</sup> “The European Fusion Research Programme. Input to the Facility Review Panel prepared by the EFDA Leader, the EFDA Associates and F4E” 2008

<sup>6</sup> R. Cashmore, J.M. Delbecq, V. Elsendorn, T. Hartkopf, E. Iarocci, K. Itoh, J. Li, R. Parker, V. P. Smirnov, H. Bruhns “R&D Needs and Required Facilities for the Development of Fusion as an Energy Source” (2008) Report of the Facilities Review Panel

The roadmap addresses three separate periods with distinct main objectives.

- **Horizon 2020 (2014-2020)** with five overarching **objectives**<sup>8</sup>
  - 1 Construct ITER within scope, schedule and cost;
  - 2 Secure the success of future ITER operation;
  - 3 Prepare the ITER generation of scientists, engineers and operators;
  - 4 Lay the foundation of the fusion power plant;
  - 5 Promote innovation and EU industry competitiveness.
- **Second period (2021-2030):**
  - Exploit ITER up to its maximum performance and prepare DEMO construction.
- **Third period (2031-2050):**
  - Complete the ITER exploitation; construct and operate DEMO.

Horizon 2020 milestones and resources have been defined in detail, while a global evaluation is given for the second period and the third one is only outlined.

---

<sup>7</sup> Y. Capouet, S. Cowley, G. Hasinger, K. Hesch, G. Marbach, J. Pamela, A. Pizzuto, F. Romanelli, J. Sanchez, M. Q. Tran, R. Weynants, S. Zoletnik "Report of the CCE FU on JET and the accompanying programme" CCE FU 50/2

<sup>8</sup> C. Cesarsky, Ph. Garderet, J. Sanchez, M. Q. Tran, C. Varandas, B. Vierkorn-Rudolph, S. Pa dassi "Strategic orientation of the Fusion Programme - Report of a group of experts assisting the European Commission to elaborate a roadmap for the fusion programme in Horizon 2020 – the Framework Programme for Research and Innovation" CCE-FU 53/3c

<sup>9</sup> A. Wagner, H. Chang, J.M. Delbecq, M. T. Dominguez, L. Maiani, W. Dominik, R. Orbach, J. Wood "Strategic orientation of the EU Fusion Programme (with emphasis on Horizon 2020) - Report by an Independent Expert Group Review Panel of the European Commission" Ref Ares (2011) 1114818

<sup>10</sup> P. Batistoni, S. Clement Lorenzo, K. Kurzydowski, D. Maisonnier, G. Marbach, M. Noe, J. Paméla, D. Stork, J. Sanchez, M.Q. Tran, H. Zohm "Report of the AHG on DEMO activities" CCE-FU 49/6.7



## 2. ITER – The key facility of the roadmap



Image: Agence ITER France



ITER is the key facility of the roadmap. ITER is expected to achieve most of the important milestones needed on the path to a fusion power plant (FPP), notably robust burning plasma regimes, the test of the conventional physics solution for power exhaust and the validation of the breeding blanket concepts. ITER construction has triggered major advances in enabling technologies for the construction of the main components and of the auxiliary systems. The ITER licensing process has confirmed the intrinsic safety features of fusion and incorporated them in the design. Thus, ITER success remains the most important overarching objective of the programme and, in the present roadmap, the vast majority of resources in Horizon 2020 are devoted to ensure that ITER is built within scope, time and budget, that its operation is properly prepared and that a new generation of scientists and engineers is trained for its exploitation.

ITER will continue to play the key role over the other two periods of this roadmap. The ITER exploitation up to its maximum performance (demonstration of a fusion gain  $Q=10$ ) will require focussed effort by scientists and engineers during the period 2020-2030. In the period 2030-2040 ITER will complete its objectives by qualifying advanced regimes of operations. In order to continue to make research at the cutting edge, ITER, like any other major facility, will require upgrades. The most likely upgrades have been considered in the present roadmap for the period 2020-2030.

The assumption made here is that ITER will be built according to specification and within cost and schedule. All contracts for the main components (toroidal field magnets, vessel and buildings with poloidal coils to follow shortly) have been launched and the R&D activities on heating and diagnostic systems, which are expected to mobilise significant resources in the European fusion laboratories, are being started. To ensure a proper management and integration of these activities is the responsibility of Europe's ITER Domestic Agency, Fusion for Energy (F4E). The related work is not described here, but the section on resources includes those foreseen for ITER.

Since ITER is expected to achieve the main scientific milestones on the path to the FPP, the risk mitigation strategy proposed in this roadmap has been to a large extent built on that proposed by the ITER Organization (IO) to prepare ITER operation. Most of the Work Packages proposed will at the same time secure ITER success and provide the basis for the decision on the demonstration FPP.

## ITER

ITER, the world's largest and most advanced fusion experiment, will be the first magnetic confinement device to produce a net surplus of fusion energy. It is designed to generate 500 MW fusion power which is equivalent to the capacity of a medium size power plant. As the injected power will be 50MW, this corresponds to a fusion gain  $Q=10$ . ITER will also demonstrate the main technologies for a fusion power plant. .

The realisation of fusion energy depends fully on ITER's success. Therefore, the vast majority of resources in Horizon 2020 are dedicated to the construction of ITER and the preparation of its exploitation. ITER is currently being built in southern France in the framework of a collaboration between China, Europe, India, Japan, Korea, Russia and the USA.

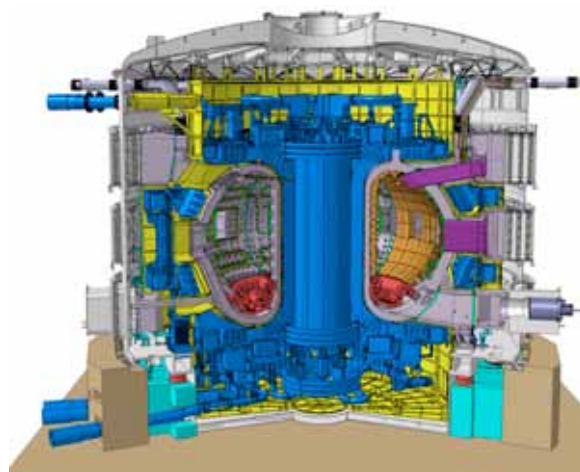

Picture: ITER Organization

### 3. A pragmatic approach to fusion energy – Fully exploit the potential of innovation



*Artist's impression based on European Fusion Power Plant Conceptual Study*

In the European strategy DEMO is the only step between ITER and a commercial fusion power plant. Its general **goals** are<sup>11</sup>:

- 1 Produce net electricity for the grid at the level of a few hundred MWs;
- 2 Breed the amount of tritium needed to close its fuel cycle; and
- 3 Demonstrate all the technologies for the construction of a commercial FPP, including an adequate level of availability.

To meet the goal of fusion electricity demonstration by 2050, DEMO construction has to begin in the early 2030s at the latest, to allow the start of operation in the early 2040s. As shown in the remainder of this paper, **meeting such a schedule is possible provided ITER achieves its goals, the innovation potential is fully exploited on the more critical issues and a pragmatic approach to DEMO is chosen.**

### DEMO: The step between ITER and a commercial power plant

DEMO will mark the very first step of fusion power into the energy market by supplying electricity to the grid. DEMO will largely build on the ITER experience. Beyond that,

- DEMO will breed its own fusion fuel tritium.
- DEMO will need materials suitable for handling the flux of neutrons produced in the fusion reactions.

To achieve fusion electricity by 2050, DEMO construction has to start in the early 2030s, immediately after ITER achieves the milestone of a net energy surplus. DEMO engineering design will become a major activity after 2020.

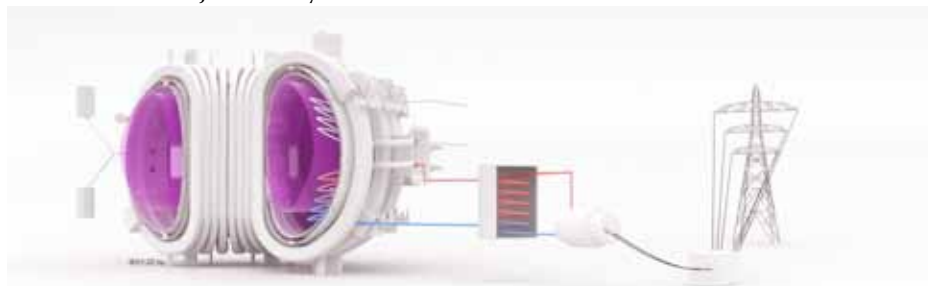

DEMO requires a significant amount of innovation in critical areas such as heat exhaust, materials and tritium breeding. On the other hand, to design DEMO on the basis of the ultimate technical solutions in each area would postpone the realisation of fusion indefinitely. For this reason a pragmatic approach is advocated here. To meet its general goals, DEMO will have to rely on simple and robust technical solutions and well established and reliable regimes of operation<sup>12</sup>, as far as possible extrapolated from ITER, and on the use of materials adequate for the expected level of neutron fluence. In addition, DEMO must be capable of addressing goal 3 also through the test of the advanced components and technical solutions that will be developed in parallel for application in a fully-fledged

<sup>11</sup> P. Batistoni, S. Clement Lorenzo, K. Kurzydowski, D. Maisonnier, G. Marbach, M. Noe, J. Paméla, D. Stork, J. Sanchez, M.Q. Tran, H. Zohm "Report of the AHG on DEMO activities" CCE-FU 49/6.7

<sup>12</sup> The choice of the DEMO regime of operation will depend on the ITER results. However, regimes based on advanced physics would require advanced technologies as well. For example, the heat-exhaust problem, more complex for advanced regimes, and the need of considerable auxiliary power for plasma control, that requires high thermodynamic efficiency cycles, imply that advanced physics does require advanced technological solutions

FPP, thus playing the role of a component test facility as part of its mission. The technologies desirable for advanced fusion power plants and as risk reduction elements, but not mature enough to be incorporated in DEMO, will have to be pursued in parallel.

Innovation is already being pursued in fusion both in industry and in research laboratories but it is only by facing the challenge of the realisation of large projects like ITER and DEMO that their synergy can be fully exploited. For this reason, a close interaction between industry and laboratory through “consortia” is envisaged and discussed below. Innovation here refers to:

- Innovation in industry, through the development of enabling technologies and the selection of effective technical solutions for DEMO. This requires an early involvement of industry as a full partner in a number of key areas: Utilities and vendors for the general layout; Manufacturers for the components with the largest capital investments and the development of advanced materials;
- Innovation in research laboratories, through the investigation of advanced concepts in the most critical areas and pursuing basic research. This requires promoting cutting-edge research and closing the research activities that have exhausted their innovative potential.

Thus, as in all large science projects, success relies on the balance between pragmatism and innovation. This approach, together with the R&D for risk mitigation proposed here, will foster innovation taking full benefit of the ITER experience and ensuring a single step to a commercial fusion power plant.





## 4. The fusion challenges

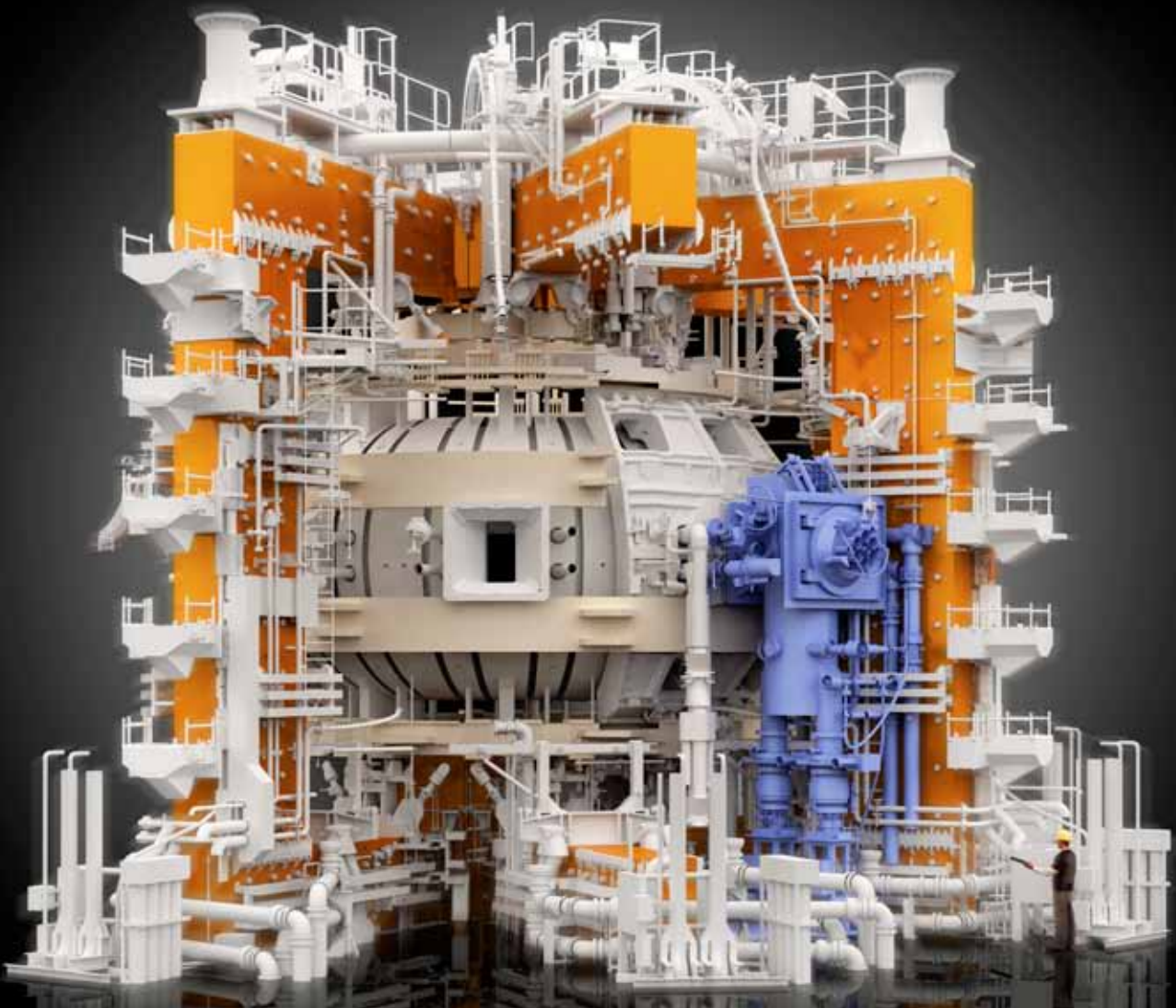

*JET, the Joint European Torus, was the first fusion experiment to generate substantial amounts of fusion power. This computer generated image shows the donut-shaped plasma chamber (grey) with an open port for a heating or diagnostic device. Also shown are the transformer limbs (orange) and a pumping station (blue).*

The realisation of fusion energy has to face a number of challenges:

- 1 Plasmas must be confined at temperatures 20 times higher than the temperature of the core of the sun. This requires the minimisation of energy losses due to small-scale turbulence and the taming of plasma instabilities. Magnetic confinement configurations with the potential for effective plasma confinement have been selected. **Plasma regimes of operation** have been developed and qualified for the ITER design. These will require advances above the ITER baseline to meet the requirements for DEMO.
- 2 The power necessary to maintain plasmas at high temperatures is ultimately exhausted in a narrow region of the reaction chamber called the divertor. The need to withstand large heat loads led the development of plasma facing materials and exhaust systems that should be adequate for ITER. However, the development of an adequate solution for the much larger **heat exhaust** of DEMO is still a challenge.
- 3 **Neutron resistant materials** able to withstand the 14MeV neutron flux and maintain their structural and thermal conduction properties in a sufficiently wide window of operation need to be developed for DEMO to ensure efficient electricity production and adequate plant availability. The ultimate goal is to produce suitable structural and high-heat flux materials that also exhibit reduced activation so as to avoid permanent waste repositories.
- 4 **Tritium self-sufficiency** is mandatory for DEMO, which will burn about 0.4kg of tritium per operational day. Tritium self-sufficiency requires efficient breeding and extraction systems to minimise tritium inventory. The choices of the materials and the coolant of the breeding blanket will have to be made consistently with the choice of the components for the transformation of the high-grade heat into electricity (the so-called Balance of Plant).
- 5 While fusion has **intrinsic safety** features, their implementation in a coherent architecture needs to be a key goal for any DEMO design, to ensure the inherent passive resistance to any incidents and to avoid the need of evacuation in the worst incident case. The development of methods for reducing the problem associated with the presence of tritium in the components extracted for disposal and the definition of appropriate disposal routes is the main development needed.
- 6 Combining all the fusion technologies into an **integrated DEMO design** will benefit largely from the experience that is being gained with the ITER construction. Nevertheless, compared with ITER, DEMO will need a more efficient technical solution for remote maintenance as well as highly reliable components: To ensure an adequate level of reliability and availability will be one of the primary goals. In addition, DEMO will need to exploit a complete Balance of Plant (BoP) including the heat transfer and associated electrical generation systems.
- 7 In order to have a rapid market penetration, fusion will have to demonstrate the potential for **competitive cost of electricity**. Although this is not a primary goal for DEMO, the perspective of economic electricity production from fusion has to be set as a target, e.g. minimising the DEMO capital costs. Building on the experience of ITER, design solutions demonstrating a reliable plant with a high availability, serving as a credible data basis for commercial energy production, will have to be pursued. Socio-economic research activities on fusion energy (SERF) will also help in maintaining a long-term perspective and optimising the strategies for market penetration of fusion.



For all of these challenges candidate solutions have been developed and the goal of the programme is to demonstrate that they work also at the reactor scale. Seven different missions have been defined and assessed. In order to secure the achievement of each mission, appropriate risk mitigation strategies have been developed. A specific assessment has been carried out in parallel for the materials for a fusion reactor and is detailed in a separate document<sup>13</sup>.

In addition, a specific mission has been defined to **bring the stellarator line to maturity** as a possible long-term alternative to tokamaks. Stellarators have indeed intrinsic advantages relative to the tokamak, but their physics basis is not mature enough to achieve the goal of electricity from fusion by 2050.

For all the missions, **theory and modelling** effort will be crucial in providing the capability of extrapolating to DEMO/FPP the available results through a careful validation of models and codes. This will also require detailed measurements in relevant experimental conditions. Special provisions should be made for high-performance computing and related supporting activities to promote both basic research and the modelling effort under the various missions.

---

<sup>13</sup>Assessment of the EU R&D programme on DEMO Structural and High-Heat Flux Materials” D. Stork et al. September 2012.



## 5. How to face the challenges – The missions for the realisation of fusion

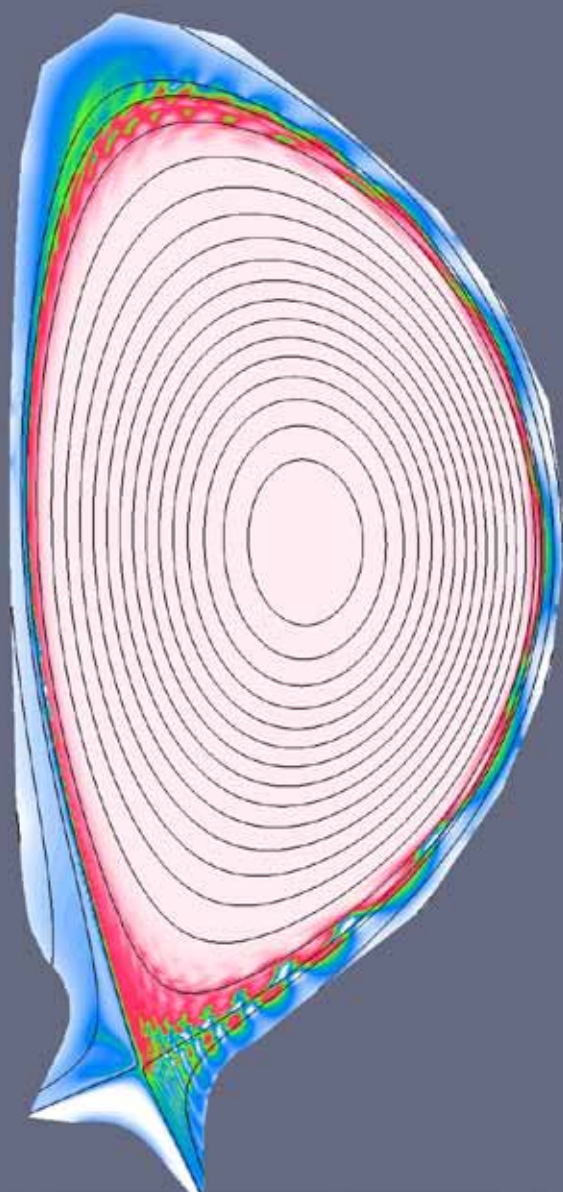

*Theory and modelling are essential for completing the milestones in this roadmap. Extrapolating solutions to DEMO, for instance, cannot be done without developing and validating suitable models. Considerable progress has been made with detailed modelling and the simulation of plasma evolution, control, stability and its impact on materials is now routine. The models need to be improved further and integrated into whole scenario models. The picture shows the simulation of an ITER plasma based on the code JOREK (Image: Guido Huijsamans, ITER Organization)*

The roadmap is articulated in eight missions. For each mission a specific analysis has been made of the critical aspects for reactor application, the technology readiness level, the risks and risk mitigation strategies and the gaps<sup>14</sup>. These are detailed in the annexes together with the high-level work packages to be implemented by the research institutions, universities and the industry for the achievement of the roadmap objectives. The detailed breakdown of these work packages during programme execution will be made on the basis of the priorities for ITER, DEMO and the FPP and on the basis of scientific and technical excellence. Given the cross links between the different missions, and notably Missions 1 and 2, special care will be taken in the implementation to ensure the consistency of the programme.

### Mission 1. Plasma regimes of operation

Plasma regimes of operation (based on the tokamak configuration) for reactor application need to achieve high fusion gain by minimising the energy losses due to small-scale turbulence and by taming plasma instabilities. In addition, in order to comply with acceptable heat loads on the divertor (Mission 2) a large fraction of the heating power must be radiated from the confined plasma, whilst minimising any adverse impact on fusion power production. Ideally, these regimes would need to be maintained in fully steady-state conditions. However, on the basis of the pragmatic approach described above, it may be sufficient, at least for DEMO, to maintain them for duration of a few hours (inductive regimes). Specific emphasis should be given to plasma control obtained with systems compatible with the harsh reactor conditions and avoidance/mitigation of disruptions and edge-localised modes must be ensured.

#### JET: The testing-ground for ITER operation

JET, the Joint European Torus, is the world's largest magnetic fusion device. It is the only experiment capable of using tritium and special wall materials like beryllium. About 100 European and international fusion laboratories participate in the JET programme. JET served as a blueprint for the ITER construction and now JET experiments are devoted to validate the ITER design choices and prepare ITER operations. With its recent upgrade, JET is even closer to ITER, which also makes it an ideal ITER test ground. Recognising JET's unique capability, the possibility of a larger involvement of the other ITER parties in JET is being pursued.



*The JET plasma chamber, newly fitted with a wall composed of the same material mix as foreseen for ITER (ITER-Like-Wall)*

<sup>14</sup> Gaps are defined here as part of the programme that cannot be addressed with the existing facilities or those under construction.

### JT-60SA: qualifying steady-state regimes for ITER

JT-60SA is a device being built by Japan and Europe at the Naka Fusion Institute in Japan. JT-60SA is similar in size to JET but in addition features superconducting magnets. It will operate in steady-state conditions and at high plasma pressures, both key issues for the preparation of advanced regimes of operation in ITER. JT-60SA first plasma is expected in 2019. Prior to this, suitable advanced plasma regimes of operation will be developed on the relevant existing fusion experiments.

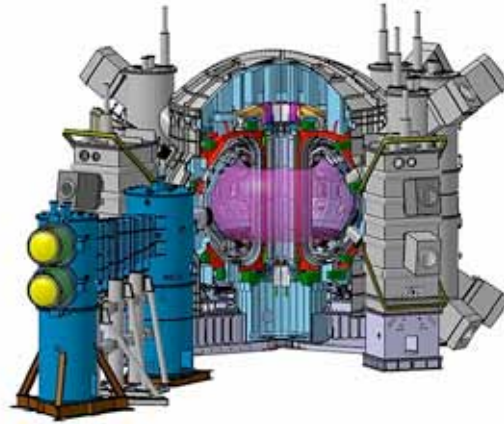

Image: JT-60SA

Mission 1 will be completed by ITER, providing the basis for the plasma regimes of operation in a FPP. Its inductive regimes of operation will be demonstrated by 2030 and steady state regimes of operation by 2040. In this regard, it should be noted that ITER will have to address scenario issues for DEMO that go beyond the achievement of the headline missions of  $Q=10$  (inductive) and  $Q=5$  (steady-state). In particular, it will be necessary to investigate the compatibility between high radiation and high confinement up to the maximum possible radiated power fraction and taking advantage of the proposed upgrades (see Annex 1) to reach the maximum possible level of input power. In Mission 1, the main risk mitigation measures are the preparation of ITER operation on JET (inductive regimes) and JT-60SA (steady-state regimes). Small and medium sized tokamaks, both in Europe and beyond, with proper capabilities<sup>15</sup>, will play a role on specific work packages. Options for their implementation on existing facilities are discussed in the annexes. Besides JET, in Europe most of these capabilities are available in ASDEX Upgrade which is expected to play an important role during Horizon 2020 for the preparation of the ITER advanced regimes of operation.

No major gaps exist in the foreseen world programme for Mission 1. However, the success of ITER and DEMO will rely on adequate enhancements of ITER and JT-60SA to be carried out in the period 2021-2030. These include enhancement of the heating and current drive capabilities and operation with a full tungsten wall.

### Mission 2. Heat-exhaust systems

Heat-exhaust systems must be capable of withstanding the large heat and particle fluxes of a fusion power plant. The baseline strategy for the accomplishment of Mission 2 consists of reducing the heat load on the divertor targets by radiating a sufficient amount of power from the plasma and by producing “detached” divertor conditions. Such an approach will be tested by ITER, thus providing an assessment of its adequacy for DEMO. However, the risk exists that high-confinement regimes of operation are incompatible with the larger core radiation fraction required in DEMO when compared with ITER. If ITER shows that the baseline strategy cannot be extrapolated to DEMO, the lack of an alternative solution

<sup>15</sup>The relevant capabilities depend on the specific work package and include: ITER-like geometry, metallic plasma facing components, auxiliary systems required for realizing ITER scenarios

### Keeping the plasma under control

Achieving conditions in which a net surplus of fusion energy is produced, requires maintaining plasmas at high density and temperature for a few hours or even in steady state. The respective plasma regimes of operation must simultaneously ensure:

- The active control of plasma instabilities, which cause energy losses or bring the hot plasma in contact with the chamber wall.
- That the heat produced in the plasma is redistributed on the walls by radiation and large localised heat loads are avoided.



*Plasma in ASDEX Upgrade, one of the tokamaks used to develop plasma schemes of operation. (Picture: IPP)*

Plasma regimes of operation that fulfil most of these criteria have been demonstrated in the existing devices. These regimes are being further developed on JET and on small/medium size tokamaks, with proper capabilities, in order to secure and even exceed the ITER goals.

would delay the realisation of fusion by 10-20 years. Hence, in parallel with the necessary programme to optimise and understand the operation with a conventional divertor, e.g. by developing control methods for detached conditions, in view of the test on ITER, an aggressive programme to extend the performance of water-cooled targets and to develop alternative solutions for the divertor is necessary as risk mitigation for DEMO. Some concepts are already being tested at proof-of-principle level in  $\leq 1\text{MA}$  devices (examples are super-X, snowflake, liquid metals). These concepts will need not only to pass the proof-of-principle test but also an assessment of their technical feasibility and integration in DEMO, perhaps by adjusting the overall DEMO system design to the concept, in order to be explored any further. The goal is to bring at least one of the alternative strategies (or a combination of baseline and some alternative strategy) to a sufficient level of maturity by 2030 to allow a positive decision on DEMO even if the baseline divertor strategy does not work.

As the extrapolation from proof-of-principle devices to ITER/DEMO based on divertor/edge modelling alone is considered too large, a gap exists in this mission. Depending on the details of the most promising chosen concept, a dedicated test on specifically upgraded existing facilities or on a dedicated Divertor Tokamak Test (DTT) facility will be necessary. The DTT could be either a new or an upgraded facility, entirely devoted to the divertor problem, but with sufficient experimental flexibility to achieve the overall target. The facility needs to be ready in the early 2020's and is a good opportunity for joint programming among the EURATOM member states and for international collaboration. Again, as the extrapolation to DEMO will have to rely on validated codes, theory and modelling effort is crucial for the success of this Mission.



### Mission 3. Neutron resistant materials

The completion of Missions 2 and 4 requires the successful development of neutron resistant materials for DEMO. A DEMO starting in ~2030 poses stringent timing requirements<sup>16</sup> as materials must be qualified in advance of the completion of the design. The present indications are that the 'baseline' materials portfolio for DEMO will consist of consolidated developments of EUROFER as a structural material for the breeding blanket, tungsten as the plasma facing component armour and copper alloys for the divertor coolant interface. Within Horizon 2020, consolidation will include a focussed programme on characterisation, irradiation (including isotopic tailoring experiments) and modelling of these 'baseline' materials. Characterisation can only be completed with a number of 'medium sized' facilities (such as high-heat flux and plasma stream test beds).

Although it is in principle possible to rely on the existing portfolio of structural and high heat flux materials for DEMO, a number of high-impact risks can be identified. The fusion programme has, in particular, produced the successful development of EUROFER as a low-activation structural material optimised for helium gas cooled blankets, (e.g. HCPB, HCLL), operating typically between 350 and 550°C. To allow a much larger operating temperature window (presently limited at the low temperature end by embrittlement and at high temperature by creep-fatigue strength) development of 'risk-mitigation' materials with more 'advanced' characteristics is essential. The portfolio of risk-mitigation materials must be selected early in Horizon 2020 from materials that have reached a minimum 'proof-of-principle' level of development at that time. From this level the experience of the fission nuclear industry shows that ~ 10-15 years are needed to produce a fully developed and characterised nuclear-grade material. There are two separate structural materials development from which this 'down-selection' of a candidate risk-mitigation structural material could be made: The ODS steels, already under modest development in the fusion programme and the high-temperature Ferritic-Martensitic (FM) steels. The latter are essentially developments of the FM steels from which EUROFER was itself developed, effectively being 'Fourth Generation' FM steels. A 'Generation IV EUROFER' low activation version of these steels is in many ways a logical development. Resources will have to be committed in Horizon 2020 to support one of these developments. Particularly for the high-temperature FM steels there is synergy with other advanced material programmes outside fusion<sup>17</sup>. At the end of Horizon 2020, an assessment can then be made to establish if the risk-mitigation materials have sufficiently proven advantages to be incorporated into the baseline design. Similarly, risk-mitigation materials for high heat flux applications will have to be developed in Horizon 2020. Also in this case there should be an effort on seeking synergies with other community-funded advanced materials programmes, such as has happened previously with the EU-funded research project EXTREMAT. Materials development must include strong emphasis on the industrialisation of the candidate materials, including issues of fabricability and joining techniques. This should have a strong participation of industry as a full partner and implies again potential bidding for funds outside fusion.

The programme of development of functional materials for tritium breeding is intimately connected with the Mission 4 (tritium self-sufficiency) developments. There are essentially two functional material concepts: 'pebble-bed' lithium compound with beryllium/beryllium-compound neutron-multiplier; and liquid metal breeder-multiplier. Both these concepts are to be tested on ITER in the EU Test Blanket Module (TBM) programme, and this will be the main development route during Horizon 2020. The fabricability of these concepts, the issues relating to material interaction with the containing structure and coolant, and the extraction of tritium from systems containing these concepts, all have a strong 'systems engineering' aspect, and are covered under Mission 4 as a result (see below).

<sup>16</sup> Assessment of the EU R&D programme on DEMO Structural and High-Heat Flux Materials" D. Stork et al. September 2012

<sup>17</sup> A (non-unique) example is the Research Fund for Coal and Steel, which currently distributes community funds ~40M€ per annum



It should be emphasised that, in a different way from fission, where available irradiation volumes for materials are not constraining, material computer modelling needs to play an increasing role in the development of fusion materials, amongst others: to guide and interpret the 'surrogate' fission irradiations using isotopic or chemical tailoring; to predict and interpret the fusion irradiations at low doses and hence to help guide and shape the mission of an 'early stage' to the IFMIF programme; in short to help keep to the stringent time requirements for the DEMO decisions.

A major gap exists in Mission 3 as a key issue is the effect of helium embrittlement, particularly important with high energy neutrons, in addition to the displacement damage already observed with a fission spectrum: Thus irradiation studies with a 'Fusion Neutron Source' device will be essential up to a minimum reasonable level of ~30dpa (steel), or 5-10dpa (tungsten and copper) before the DEMO design can be finalised. Whilst a full performance IFMIF provides the ideal Fusion Neutron Source device, as already identified in the Fast Track approach, for testing materials up to dpa levels foreseen for a FPP, the schedule for DEMO is such that the tests must start earlier than currently foreseen for a full IFMIF. To accelerate the testing schedule requires an assessment of an early start to an IFMIF-like device with a reduced specification and of the possibility of a staged approach to the full IFMIF. This assessment should be completed before Horizon 2020 commences. There are proposals for achieving this aim, such as an upgrade of the IFMIF EVEDA hardware. This and other risk reduction measures need evaluation. In any case, the detailed design and procurement of the chosen device would require funds to be committed in Horizon 2020.

#### Mission 4. Tritium self-sufficiency

The leading role in ensuring tritium self-sufficiency will be played by the ITER TBM programme which will demonstrate the capability of producing tritium and high-grade heat for breeding blanket designs based, in the case of Europe, on the eutectic Pb-16Li and the ceramic breeder and the use of He in both cases as coolant. As a risk mitigation strategy it is seen as necessary to foresee the evaluation, and potentially, the development of parallel lines, such as a water-cooled lithium lead concept, in addition to the two design concepts based upon He cooling.

For an efficient balance of plant, a credible programme for the power conversion system, including both the blanket and the divertor and, in particular, a reliable balance of plant model, has to be developed. The choice of the BoP has a number of consequences on the choice of

#### Materials that could survive on the sun

The centre of a fusion plasma is more than 100 million °C hot. The cooler, but still very hot edge plasma flows into a remote area of the reactor, called divertor, where it is exhausted. The divertor must be designed to withstand the high heat and particle fluxes from the plasma. Suitable concepts are available and will be tested on ITER and, if successful, extrapolated to DEMO. Materials that resist heat fluxes up to 20 MW/m<sup>2</sup>, which is of the same order as the heat load on the sun's surface, have been produced for ITER. Alternative, back-up divertor concepts are under investigation and need to be brought to sufficient maturity by 2030 through a dedicated experimental programme.



*Hot spots on the chamber wall caused by plasma instabilities (here: JET). In DEMO and fusion power plants, these heat fluxes require new divertor concepts.*

## Handling the fusion neutrons

The fast neutrons from the fusion reaction (see page 5) activate and damage divertor and blanket, so that these components must be periodically replaced. To avoid too frequent replacements, the materials, of which divertor and blanket are made, must be resistant to neutron bombardment. Also, their activation rate must be low enough to fulfil the requirement to avoid the need of a permanent storage after decommissioning. The fusion programme has already successfully developed reduced-activation steels. Further developments are foreseen of these steels, as well as of other materials with more advanced features for reactor applications.

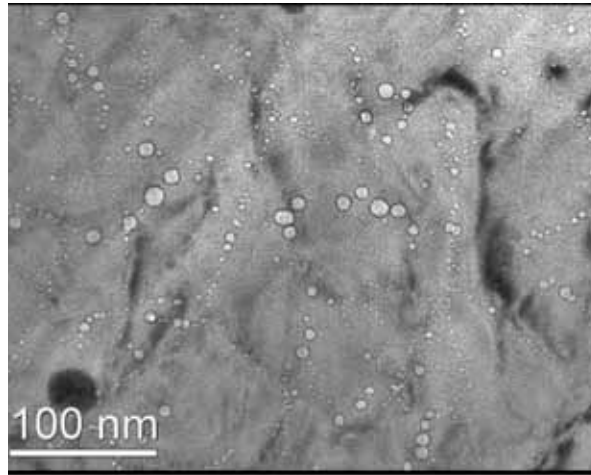

*High-energy neutrons cause helium bubbles in steel.  
(Image: F4E)*

blanket coolant and materials. Both water-cooled and helium-cooled BoP shall be designed, modelled, analysed and evaluated using appropriate tools and the involvement of industrial experts. Basic test-bench R&D on some of the key issues specific to fusion (T-control in heat exchangers, response to cyclic operation, BoP component failure modes, etc.) will be needed. The final choice of the coolant has to be made before the start of the DEMO Engineering Design Activity (EDA).

DEMO will substantially benefit from the experience gained in the operation of the ITER fuel cycle system (e.g. fusion environment, processing technologies, RAMI and tritium safety data). Nevertheless, a development in the field of removal and processing of tritium from candidate breeder blanket systems will be needed to reduce the processing time, thereby improving system availability. Demonstration of efficient tritium extraction methods and reliable and a long lifetime permeation barrier are areas of R&D where large gaps still exist. Additional testing of blanket sub-elements in fission reactors, e.g., high-dose breeder/multiplier performance in fission reactors are needed for material characterisation.

Most of the existing technology facilities seem adequate to develop the programme in support of the baseline strategy and the parallel lines during Horizon 2020. Upgrades may be required for some of the coolant loops, tritium extraction and tritium permeation facilities. The need for testing of mechanical and thermal hydraulic performance of blanket/first wall mock-ups in a non-nuclear environment on a dedicated test stand should be also assessed. As for the use of nuclear component test facilities, opportunities from international collaboration in other ITER parties should be pursued through e.g. the use of the Chinese Fusion Engineering Testing Reactor (CFETR) presently under design or the Fusion Neutron Science (FNS) facility presently discussed in the US. The advantages arising from the exchange of information on TBM programmes with other ITER parties should be also evaluated.

If a different breeding blanket concept than those presently pursued by Europe in the TBM programme is selected as front-runner for DEMO at the end of Horizon 2020, a decision must be taken early in the next decade as to whether a dedicated test in an ITER TBM is required.

## Blanket technology

The blanket absorbs the energy of the fusion neutrons and heats up a cooling fluid to drive the turbine for electricity production. It also ensures the tritium breeding process and shields the components outside the reaction chamber from the fast fusion neutrons. The reactor blanket contains lithium (see page 5) and a neutron-multiplying element (i.e. beryllium or lead). Tritium is extracted from the blanket and reprocessed. Design concepts for the tritium breeding blankets are being investigated. Europe will test two of them in ITER – one based on lithium and beryllium pebbles, the other one based on a lithium-lead fluid.

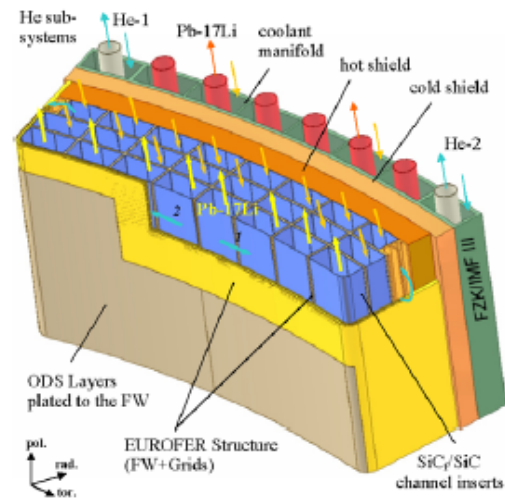

*Schematic of a dual-cooled tritium breeding blanket, one of several concepts developed in Europe (PPCS)*

## Mission 5. Implementation of the intrinsic safety features of fusion

The experience of the ITER licensing process has provided a confirmation of the intrinsic safety of fusion and has pointed out the areas that are expected to really impact the licensing of a fusion power plant. In this field, the main differences between ITER and DEMO will be the management of tritium, with much larger tritium throughput and inventories in DEMO as well as the higher neutron fluence on the blanket, with the associated challenges related with the management of activated materials. Investments will have to be made in the development of efficient detritiation techniques and in the selection of adequate disposal routes. The experience of ITER emphasises that the safety of the device against 'Design Basis Accidents' must be assured by 'passive safety' and 'defence in depth', and puts the emphasis for a toroidal confinement device on the integrity of the vacuum vessel, the existence of expansion volumes, and the limitation of directly mobilisable inventories. In this sense, the structural integrity of the internal components will not be the primary licensing issue, provided engineering (e.g. double containment) barriers are designed in. Nevertheless the investment decision of the funding bodies will demand a developed engineering code for the design of in-vessel components such that the risk to the DEMO Mission (technically, economically and politically) is demonstrably very low level. Although some of the materials to be used will be in an early stage of development, it is expected that it will be possible to exploit the benefit of reduced activation materials already for the first set of DEMO in-vessel components. Hence, specific techniques for recycling will have to be developed in parallel to the development of low activation materials.

### Fusion power is intrinsically safe and environmentally responsible

There are no chain reactions in a fusion power plant. A fusion plasma contains at any point of time only few grams of fuel and would extinguish within seconds in case of an interruption. The Fusion Power Plant Conceptual Study has shown that in case of an accident in the plant no evacuation would be necessary. A fusion power plant does not produce long-lived radioactive waste. The parts of a decommissioned plant can be recycled for use in a new reactor after 100 years of storage. The radioactive fusion fuel tritium is produced and burned inside the plant in a closed cycle. Experience with its storage and processing is already available and will be further developed by ITER.

### Mission 6. Integrated DEMO design and system development

The experience gained in the ITER construction will be used directly for the integrated DEMO design, but specific system development will be required in some areas. Above all, special emphasis will have to be given to the maintainability and reliability of components.

- The ITER technology of Nb<sub>3</sub>Sn magnets forms the basis for DEMO, but more advanced cable solutions should be developed during Horizon 2020 to reduce degradation of performance under cyclic operation and overall system cost. A simpler magnet construction would also reduce costs.
- In the area of heating and current-drive systems
  - In neutral beam systems, no need is foreseen to increase energy above 1MeV at least for a DEMO that does not require a significant amount of driven current. Modularity could improve reliability but has to rely on increased negative ion source current density. Main lessons will be learned from ITER. Improved efficiency through energy recovery systems and improved neutralisation should be considered.
  - An increase in the frequency of electron cyclotron systems (up to ~230GHz) will be required together with step tunability and broadband window development (or remote steering). Modularity is considered to be the right approach to high system reliability and can be ensured by moderate power units. Increase of source efficiency above present values (~50%) is mostly a Mission 7 target.
  - No major R&D activities in ion cyclotron and lower hybrid current drive systems beyond those that will be carried out on ITER and will progress on medium sized devices (e.g. to test new antenna concepts) are presently considered. A decision on the applicability to DEMO will have to be taken on the basis of the tests on ITER and other tokamaks.
- The development of the remote maintenance system for DEMO is driven by the need to maximise the overall plant availability and minimise the plant down time for maintenance. To achieve this:
  - Novel concepts, relying on vertical maintenance of large segments must be developed and validated, in particular, for the breeding blanket system. This requires that the design of the in-vessel components (Mission 2 and Mission 4) and their interfaces be optimised for reliable remote handling (RH) operations from the outset.

- Validation of specific design concepts for maintenance aspects such as in-vessel attachments, remote maintenance transporters and servo manipulators is needed. This requires in-depth engineering studies and preliminary demonstration with simplified mock-up and test facilities.
  - Conceptual design of ex-vessel RH (near-vessel inside bio-shield), of some balance of plant components, of transport systems and of hot cell RH is required.
- The need for a self-sufficient tritium fuel cycle and pulses of a few hours demands systems based on either a cryopump or continuously working pumps with an effective tritium separation and recycle function of the exhaust.
- It will be necessary to develop new diagnostic techniques that are DEMO relevant since many existing diagnostic techniques will not be applicable in the harsh environment of DEMO and the number of diagnostics and actuators available for plasma control will be reduced significantly. Specific activities to demonstrate the control of plasma regimes of operations with DEMO relevant systems are foreseen in Mission 1.

### Fusion R&D: promote innovation in industry and in research

In the next decades Fusion will shift from a science-driven, laboratory-based to a technology-driven, industry-based programme. The ITER construction involves about 6B€ of industrial contracts and provides employment at the equivalent of 5000 man years per year in Europe. ITER will test or validate most technological solutions for DEMO, but significant innovation is required in some areas such as superconducting magnets, microwave sources, high power beam sources, remote handling, fuelling and pumping system. The role of industrial partners will evolve from that of a provider of high-tech components to that of a driver of fusion development. This will be a step wise process, possibly through consortia including research laboratories and universities, in connection with the DEMO R&D. For this reason an early involvement of industry in the DEMO definition and design and in the fusion material development is foreseen by the roadmap already in Horizon 2020.

The analysis of DEMO requirements, system modelling and design integration of the various systems that form the overall DEMO plant is key to the success of Mission 6. It will be necessary to assess the influence of key design drivers on the achievement of the overall plant mission requirements.



## Mission 7. Competitive cost of electricity

Market penetration will require fusion energy to be competitive. The ITER experience has more than ever underlined the need to lower the cost of electricity from fusion through lower capital costs.

Rigorous evaluations of design options/solutions will provide a firm justification for the selected DEMO concept design. The lifecycle cost breakdown of the DEMO plant needs to be analysed systematically to determine the best trade off between cost and design robustness.

Extended overall operation times, high plant availability, high efficiency of the power conversion cycle and low re-circulating power through high efficiency of the heating and current drive systems will all have to be ensured for a commercial fusion power plant. To minimise capital costs, materials allowing extended operational time have to be used and simple fabrication routes for the largest machine components should be selected in close interaction with industry. Plasma regimes of operation with improved core confinement (see Annex 1) will also contribute to reduce plant size and cost.

High temperature super conducting magnets are expected to replace Nb<sub>3</sub>Sn magnets in the long term, so avoiding the use of a scarce resource like helium, increasing the reliability of a FPP by higher margin and better testing, decreasing the overall magnet cost and simplifying a FPP. Their use for DEMO application will have to be properly investigated to take benefit from the rapid developments of the technology and the possible decrease in the costs.

The reduction in size and cost of a FPP depends to a large extent on the development of advanced heat exhaust systems investigated under Mission 2.

Achievement of high efficiency of the power conversion systems depends on availability of reliable high temperature (> 700°C) structural materials, which are still at a very early stage of development. Some of the R&D needs for power conversion systems are shared with other technologies (i.e., GEN IV).

High efficiency of the heating and current drive systems requires advancement in specific technologies such as an efficient neutraliser for neutral beams and frequency step-tunable gyrotrons above 200 GHz with highest possible output power and plug-in efficiency (e.g., via multi-stage depressed collector) for electron cyclotron if remote steering proves not to be a viable option.

## Mission 8. Stellarator

In order to bring the stellarator configuration to maturity as a possible long-term alternative to tokamaks, the EU programme should focus on the optimised stellarator HELIAS line. Work on other stellarator lines (Heliotron, Compact stellarators) will continue as part of international collaborations. For the period 2014-2020, the main priority should be the completion and start of scientific exploitation of the W7-X experiment in validating the energy and particle confinement of optimised stellarators and qualifying the island divertor. Full qualification of solutions under steady-state conditions will be achieved beyond 2020. These activities will have also an impact on the progress of the basic understanding of plasma physics in support of Mission 1 and 2 and specifically in support of the ITER preparation. If W7-X confirms the good properties of optimised stellarators, a next step HELIAS burning plasma experimental device will be required to address the specific dynamics of a stellarator burning plasma. The exact goal of such a device can be decided only after a proper assessment of the W7-X results. In the long run, it is expected that this strategy could allow, together with the technology results from a tokamak DEMO, to build a stellarator FPP.

### A long term alternative to the tokamak: Stellarators

Stellarators are magnetic confinement fusion devices, which require a highly complex magnetic field shape. The tokamak configuration (used in JET, JT-60SA and ITER) is today's most advanced concept for a fusion power plant and DEMO will be designed on this basis. Stellarators, however, offer intrinsic advantages with respect to tokamaks. They have the inherent capability for steady state operation and are less prone to plasma instabilities. The world's most advanced stellarator, Wendelstein 7-X, is under construction in Germany and will start operation in 2015.



*Work inside the plasma chamber of Wendelstein 7-X (Picture: IPP)*



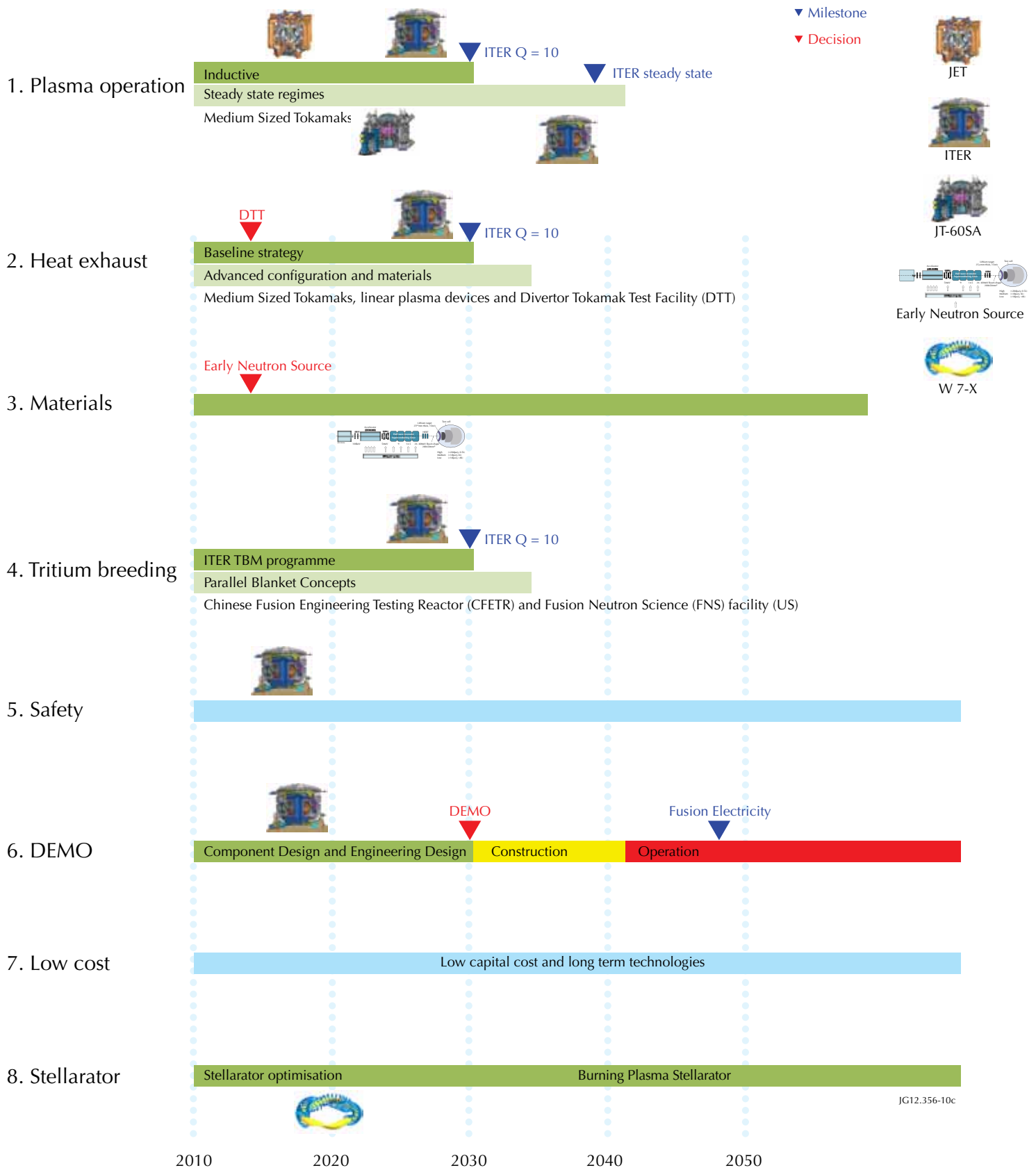

The missions to the realisation of fusion electricity



## 6. Roadmap outline and milestones

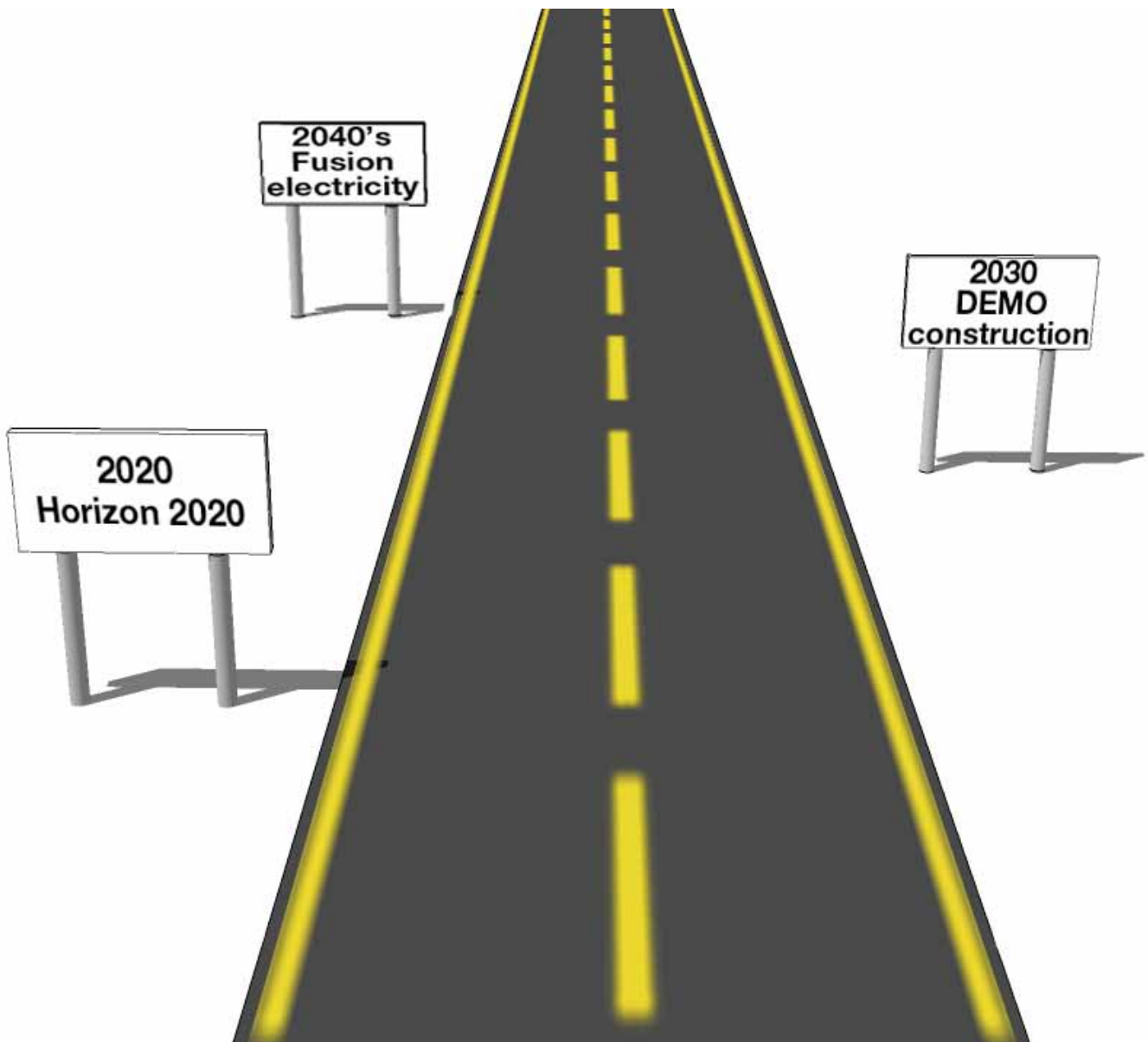

Three different periods have been considered in the roadmap. A Gantt chart with the main milestones is attached at the end of the report.

### 6.1 Horizon 2020 (2014-2020): Build ITER and Broader Approach projects within schedule and cost; Secure ITER success; Lay the foundation of DEMO.

The main milestone of this period is the timely completion of ITER and the Broader Approach (BA) projects, ensuring that the EU commitments are fulfilled, with the delivery of the EU procurements within technical specification, cost and schedule. This objective is under the responsibility of F4E contracting with industries as well as European fusion laboratories. This period will see a progressive focus of the activities in physics around a limited number of facilities that are critical for the roadmap missions. Specifically, it is essential that European scientists and engineers are prepared for a leading role in ITER exploitation by preparing ITER operation on JET and other relevant devices.

#### **Mission 1**

The main milestones are linked to mitigating the high priority risks identified in the ITER Research Plan and described in Annex 1. Demonstration of reliable mitigation methods for disruptions should be achieved by the end of this period. The compatibility of ELM mitigation methods with high-confinement operation should be also achieved with the support of substantial theory and model validation effort. Concerning JET, these milestones also include the characterisation up to full performance of the ITER regimes of operation with the same combination of plasma facing material as ITER (the JET ITER-Like-Wall), possibly followed by a DT campaign in the second half of the decade.

JET can further contribute to mitigate ITER risks by exploring ITER regimes of operation in an integrated way (i.e. with the control systems foreseen in ITER). This would require some major enhancement such as a set of ELM control coil and/or an ECRH system and the prolongation of JET operation until 2019. In order to maintain such a schedule, the process of JET internationalisation, as suggested by the Panel on Strategic Orientations of the Fusion Programme<sup>18</sup>, with a corresponding significant amount of resources made available for JET operation, needs to be defined and the associated scientific programme assessed by the end of FP7.

#### Scaling up from small to large devices

Regimes of operation can be conveniently developed in small and medium sized tokamaks, with proper capabilities, before being demonstrated in large machines like JET, JT-60SA and ITER. Proof of principle concepts are also better investigated in small and flexible experiments and then scaled up to the larger machines. Examples are the investigation of alternative divertor configurations or the use of liquid metals as plasma facing components. Furthermore, linear plasma devices support ITER and DEMO by investigating the interaction between plasma and wall materials under similar conditions.

---

<sup>18</sup> A. Wagner, H. Chang, J.M. Delbecq, M. T. Dominguez, L. Maiani, W. Dominik, R. Orbach, J. Wood "Strategic Orientation of the EU Fusion Programme (with emphasis on Horizon 2020) - Report by an Independent Expert Group Review Panel of the European Commission" Ref Ares (2011) 1114818

The JT-60SA first plasma is expected in 2019. Prior to JT-60SA operation, an adequate preparation of the advanced regimes of operation will be necessary on the relevant devices in Europe and beyond (see Annex 1). The main milestones will be the demonstration that advanced tokamak regimes can be reliably kept under control in conditions compatible with acceptable divertor/wall load and the definition of a preliminary confinement scaling law in medium sized tokamaks. Late in this period a decision on the JT-60SA enhancements will have to be taken. In particular, the use of an actively cooled tungsten first wall on JT-60SA or ITER will have to be assessed and a strategic decision taken. Operations with a tungsten wall do not need to take place before 2030. This leaves sufficient time for the design and R&D activities during the period 2020-2030.

### **Mission 2**

The ITER baseline strategy will be pursued in existing divertor devices, preferentially with all metal plasma facing components, to secure acceptable ITER divertor operation in the detached regime. Control schemes will be qualified to establish stable detached conditions also in case of slow transients and avoid damage to the ITER divertor target. To optimise the radiated power, the injection of different impurity species will be tested together with control schemes to avoid excessive contamination of the plasma core. These activities will be supported by a strong modelling and validation effort. The milestone is the demonstration of full control of detached conditions compatible with high confinement regimes by the end of the period.

A risk mitigation programme will be decided to secure a viable solution for heat exhaust on ITER and DEMO. The technological feasibility and performance of water-cooled divertor targets concepts, which extend the ITER design and technology, will be assessed. A short-list of possible alternative solutions to the baseline strategy will be completed by the end of FP7. Design, assessment of the adequacy for DEMO and proof-of-principle tests of innovative geometries/liquid metals should be completed and their viability for DEMO assessed. Specific milestones are the test of super X and snowflake configurations and of liquid metal targets in a number of small and medium sized tokamaks by the end of the period. The definition of the exact scope and technical specifications of a DTT facility (either a new facility or the upgrade of existing facilities taking benefit of the opportunities for international collaborations) will have to be completed early in Horizon 2020 and, after a thorough review, a decision should be taken for its construction by 2016.

### **Mission 3**

Investigations on how to use the IFMIF/EVEDA hardware beyond the Broader Approach are presently being pursued. This would provide a risk mitigation measure for IFMIF and could allow an early qualification of material at a DEMO relevant level of neutron damage, thus strengthening considerably the basis for a DEMO decision in 2030. An assessment should be made by the end of FP7 to decide on construction. A down selection should be made in 2016-2017 to generate a prime candidate material list (baseline plus risk-mitigation option) for structural, plasma-facing and high-heat flux zones of the breeding blanket and divertor areas of DEMO for prototyping, demonstration of welding and joining processes, and progressing towards industrialisation.

### Testing reactor materials

The qualification of the neutron resistant materials (see page 24) requires an intense source generating neutrons with the same energy of those produced in a fusion plasma. Europe and Japan are jointly engaged in an engineering validation and design activity (EVEDA) for such a neutron source, the International Fusion Materials Irradiation Facility (IFMIF). IFMIF would be the ideal neutron source for fusion material testing. However, in order to have materials qualified in time for a DEMO constructed in the early 2030s, the material development programme must be accelerated. The possibility of an early start to an IFMIF-like device with a reduced specification and the possibility of a staged approach to the full IFMIF should be considered. Proposals such as an upgrade of the IFMIF EVEDA hardware, possibly carried out in collaboration with Japan, should be assessed before Horizon 2020 commences.

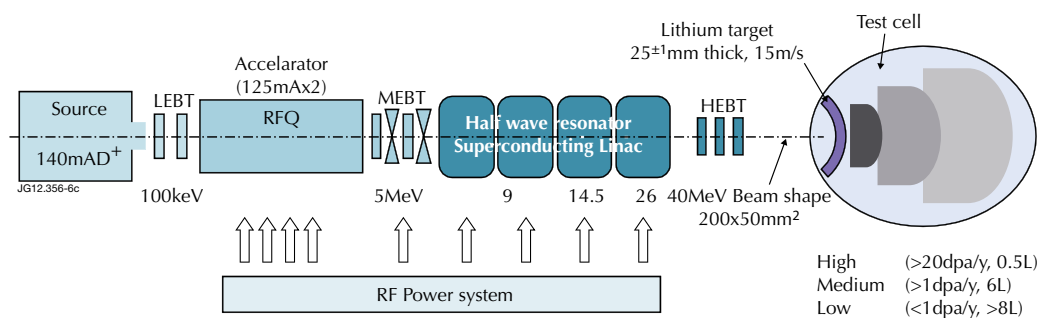

Image: IFMIF/EVEDA

#### Mission 4

Substantial R&D on the breeding blanket and fuel cycle area will be pursued in this period. Part of the R&D will be in support of the two European He-cooled concepts to be tested as part of the TBM programme. To support the definition of the optimum solution for the balance of plant (see Mission 6 below), a preliminary evaluation of alternative design solutions (such as a water-cooled lithium lead blanket) should be made early in Horizon 2020. Depending on the outcome of this evaluation, the option of launching related design activities, to be completed by 2020, should be foreseen. Other milestones are the demonstration of the performance and durability of permeation barriers on candidate materials for the different blanket concepts, and operating conditions and of the extraction of tritium from PbLi at high temperature by gas-liquid contactors, permeation against vacuum (PAV), etc., while having little or no impact on the fluid's power conversion.

#### Mission 5

Limited developments are expected in the area of safety during Horizon 2020, with the analysis of the critical aspects for the licensing of DEMO on the basis of the ITER experience. In particular, in the area of radioactive waste management, R&D to identify efficient detritiation systems from solid waste should be started in advance of a possible test on ITER components. Feasibility studies of waste recycling and proof-of-principle demonstration of related technology should also be undertaken.

#### Mission 6 and 7

Capitalising on the ITER experience, modest targeted investments in the DEMO integrated design and system development and analysis of cost minimisation



strategies are expected in Horizon 2020. Milestones are the definition of the optimum configuration, the BoP (also on the basis of the results of Mission 3 and Mission 4), the development of prototypes of advanced low-temperature super conducting cables, the definition of the RH maintenance scheme and some R&D on H&CD and vacuum and pumping systems. The DEMO Conceptual Design Activity (CDA) should be completed by the end of Horizon 2020. This should assess and integrate different designs of the breeding blanket and divertor concepts to be developed as part of Mission 4 and Mission 2, respectively.

### **Mission 8**

Will be pursued through the exploitation of W7-X and targeted design studies for a stellarator reactor. First plasma on W7-X in 2015 and fully actively cooled components in 2019 are the main milestones for Horizon 2020.

## 6.2 Second period (2021-2030): Exploit ITER up to its maximum performance and prepare DEMO construction.

During this period ITER will be the leading facility and the European laboratories will focus their effort on its exploitation. At the same time, the preparation of fully steady state regimes of operation will start on JT-60SA.

The main milestones are the demonstration of the production of high fusion gain regimes ( $Q=10$ ) in ITER (i.e. the accomplishment of **Mission 1** for inductive tokamak regimes) and the qualification of the two EU TBM concepts (**Mission 4**). Intermediate milestones are described in the ITER Research Plan. Towards the end of the period, high-beta, non-inductive operation with first wall and divertor heat loads that are compatible with metal plasma-facing components will be demonstrated so as to start the test of these regimes in ITER in 2030-40.

Reliable heat exhaust (**Mission 2**) will have to be demonstrated during this period. The test of the baseline strategy will be made on ITER by the time of the  $Q=10$  milestone. For the alternative strategies, depending on the decision on how to test them, the modification of existing facilities or the construction of a DTT facility will be completed in the first part of this period.

To support the engineering basis for DEMO, a comprehensive materials database (**Mission 3**), including 14MeV irradiation data, needs to be available by 2026 for structural steels at 30dpa and for high-heat flux divertor materials at 10dpa (tungsten/tungsten alloys), including welded and jointed samples. By 2028 the development of a set of codes & standards for the key safety important materials of DEMO should be completed and issued in conjunction with Industrial and Codes & Standards organisations.

Efficient tritium breeding and extraction (**Mission 4**) will be demonstrated on ITER and supporting facilities. In addition, a complete description of the selected blanket system and its auxiliary systems, including detailed designs with complete specifications should be available and large prototype components for the selected DEMO breeding blanket should be fabricated, in order to assess their manufacturing feasibility, assembly and remote maintainability. The test of representative parts of the components under relevant conditions should be completed. Design choices should be supported by the results of R&D on materials, joining techniques and neutronics using TBM results (low fluence) and a fast neutron source (high fluence  $\sim 30$ dpa). Efficient tritium extraction and permeation control

under representative conditions should be demonstrated. In case an alternative concept is eventually selected for the blanket, the need of a specific test on ITER beyond 2030 will have to be analysed and, if considered necessary, a decision on its implementation taken.

The engineering design activity for DEMO will have to be carried out during this period, including a preliminary licensing discussion (**Mission 5 and 6**). Structural calculations meeting the requirements of accepted code and standards as well as drawings of the components of DEMO with specific regard to their interfaces should be available. Integrated safety analysis to enable start of licensing (e.g. Safety analysis report including comprehensive identification of hazards, identification of safety functions and the corresponding safety credit to be given to systems, structures and components) will be performed. A planning schedule for the various stages of supply, construction, assembly, tests and commissioning together with a corresponding plan for human and financial resources requirements, and specifications will be produced. Final technology demonstration R&D, including development, manufacturing and testing of scalable models to ensure engineering feasibility, full assembly and maintainability will be conducted. Verification that all system and sub-system requirements shall be satisfied will be done and full system cost analysis/optimisation completed.

The exact scope of the activities on **Mission 7** will have to be defined as the perspective for the application of High Temperature superconductors to DEMO will become clearer and new technologies will have emerged. The main target will be the completion of a DEMO design that ensures a capital cost in line with the perspective of fusion energy as a competitive source.

Finally, following the results of W7-X a decision on how to progress with a next step stellarator device (**Mission 8**) will have to be taken in the second half of this decade.

### 6.3 Third period (2031-2050): Complete the ITER exploitation; Construct and operate DEMO.

The emphasis of ITER exploitation during this period will be the demonstration of regimes of operation and technologies required for DEMO. Successful development of advanced plasma regimes will have to be confirmed in ITER. A test of an all-tungsten wall would provide confidence, in a manner analogous to the ITER-Like-Wall experiment on JET, of the optimum integrated (plasma and wall) operating modes for DEMO. In addition, high fluence tests of test blanket modules will be completed in this period.

The construction and operation of DEMO will take place during this period. This third stage can only be outlined at the moment. It will be possible to assess the resources for this period only at the end of the DEMO engineering design activity.

During the initial period of operation DEMO is expected to test components, collecting directly data on their reliability. For example, it may be acceptable to utilise a 'starter' breeding blanket configuration using moderate-performance materials (which don't affect regulatory approval) and then switch to blankets with a more advanced-performance material after a limited accumulated MW yr m<sup>2</sup>. This type of approach has been used for the fuel cladding in fission reactors for many years, by limiting the maximum exposure level of the replaceable cladding to below the regulatory limit while data for higher exposure operation is generated in test reactors or load test assemblies. This approach benefits from the multiple-barrier safety approach in fission reactors, including the pressure

vessel as a key safety boundary for regulatory approval. Similarly, for a fusion DEMO, operation up to moderate exposures could be envisaged for the 'starter' blanket, while high-dose engineering data for a more advanced-materials blanket was being generated in a dedicated 14MeV neutron source. A similar philosophy should be applied to the divertor, with the possibility of a 'starter' divertor. The replacement of blankets or divertors cannot be accompanied by a complete change of the balance of plant, as this is clearly unfeasible. Thus either the series of blanket concepts and divertor concepts each assume the same coolant (although the divertor and blanket coolants could, in principle, be different) or the new components are tested in dedicated ports (in the same spirit of the ITER TBM test).

During the second phase of operation DEMO will progress towards the demonstration of high plant availability.





## 7. Training and education – Form “Generation ITER”



*FUSENET sponsored 49th Culham Plasma Physics Summer School, July 2012 (Image: CCFE)*

As noted by the Panel on Strategic Orientations of the Fusion Programme, the evolution of the fusion programme requires a shift “from pure research to designing, building and operating future facilities like ITER and DEMO”. This transition requires strengthening the available engineering resources, with a marked change from non-nuclear to nuclear technologies, and has to be facilitated during Horizon 2020 by specific measures in support of training and education.

ITER will break new ground in fusion science and the best young scientists should be encouraged to participate in the ITER programme at an early stage of their career.

Fusion laboratories and universities play a key role in providing general training and education in fusion science and technology by selecting and forming “Generation ITER”, through theoretical and experimental work on relevant facilities. Their main goal should be that of ensuring adequate access of their scientists and engineers to the leading facilities. These include JET, which represents an intermediate step towards ITER operation because of its large size (and large disruption forces), tritium capability, use of remote handling and of beryllium and is therefore the best place for training scientists and engineers for ITER operation. Similarly, engineering skills for the design and construction of DEMO need to be further consolidated through training of young engineers in the large devices currently under construction (ITER, JT-60SA, W7-X).

The role of fusion laboratories and universities in training and education should be explicitly recognised by specific support at under-graduate and PhD level through Fusenet<sup>19</sup> to be followed by post-doctoral training programmes such as the EFDA Fellowship and Goal Oriented Training EFDA programme. Training in critical qualifications should be reviewed with industry and encouraged. The existing training schemes should be enlarged to involve industry through in-company training of engineers involved in fusion-related tasks and specific training of professionals and technicians, already specialised in fusion, on technologies and standards associated with the transition of fusion to a fully nuclear technology.

A healthy system should aim in the long term at some 300 PhD students and an equivalent number of engineers (either PhD students or trainees) active in fusion, with an appropriate spread over topics in fusion engineering and physics.

---

<sup>19</sup>Fusenet (the European Fusion Education Network) is the umbrella organization under which all fusion education, from Master (and earlier) to PhD, is coordinated



## 8. Breaking new frontiers – The need for basic research

$$\vec{B} = \left( \frac{\partial A}{\partial y}, -\frac{\partial A}{\partial x}, \frac{\partial^2 \psi}{\partial z^2} \right)$$

$$\frac{1}{R} \nabla \psi \times \vec{e}_\phi - \frac{1}{R} \Delta^* \psi \vec{e}_\phi$$

$$\Delta^* \psi = -\mu_0 R^2 \frac{d\rho}{d\psi} - \frac{1}{2} \frac{dF^2}{d\psi}$$

$$\Delta^* \psi = 2 \frac{\partial}{\partial R} \left( \frac{1}{R} \frac{\partial \psi}{\partial R} \right) + \frac{\partial^2 \psi}{\partial z^2}$$

$$\vec{B} = \frac{1}{R} \nabla \psi \times \vec{e}_\phi - \frac{1}{R} \Delta^* \psi$$

$$\nabla^2 A = -\mu_0 \frac{d}{dA} \left( \rho + \frac{B_m^2}{2\mu_0} \right)$$

$$\vec{B} = \frac{1}{\mu_0} \nabla B_z \times \hat{z}$$

$$\Delta^* \psi$$
 is given by

All - Ampere:

A vigorous underlying programme should be continued in the EURATOM member states to progress physics understanding. Such a programme, distinct from the project-oriented programme in the various missions, can be “curiosity driven” and should involve both theory and experiment.

In the proposed roadmap, basic research is meant to address several areas in which fundamental understanding is required to reliably predict the integrated plasma behaviour in ITER and DEMO from first principles. Hence, it addresses ingredients necessary to reach a validated ‘numerical tokamak’ (and a ‘numerical stellarator’ as well). A (non exhaustive) list of areas that can benefit from basic research is given in Annex 10 as an example.

## 9. Industrial involvement - From provider of high-tech components to driver of fusion development



*The development of remote handling technologies for fusion offers a number of opportunities for industrial spin-offs. This image shows the Divertor Test Platform in Tampere, Finland, used to develop and test the remote handling equipment for the ITER divertor maintenance (Picture: VTT).*

Industrial involvement already represents a turnover of ~6B€ over ~10 years and involves ~5000 full-time equivalent. In the coming decades the development of fusion will move from a science-driven, laboratory-based exercise to an industry-driven and technology-driven program.

Industry must be able to take full responsibility for the commercial fusion power plant after successful DEMO operation. For this reason, DEMO cannot be defined and designed by research laboratories alone, but requires the full involvement of industry in all technological and systems aspects of the design. This will also ensure that an adequate Technology Readiness Level will be achieved in time and within budget.

Specific areas where industry involvement is considered critical are:

- Technical solution for the largest DEMO components with the lowest cost and simplest manufacturing (e.g. magnet simplification); standardisation of parts;
- Balance of plant design and integration
- Materials development must include strong emphasis on the industrialisation of the candidate materials.
- High level of component reliability, maintainability, inspectability for DEMO
- Definition, together with the research laboratories, of the priorities in the technology development
- Development of codes and standards.

Industrial involvement needs a policy to develop and maintain industrial competence in fusion-specific areas after the completion of the ITER construction and in advance of the DEMO EDA. An early launch of the DEMO EDA in the 2020-30 decade would facilitate maintaining these competences. However, without specific provisions the know-how accumulated during the ITER construction phase could rapidly disappear before the start of the DEMO EDA. As discussed more extensively in Annex 12, this requires actions to support the participation of industry in the ITER assembly, commissioning and exploitation and in the DEMO conceptual design activity, a specific knowledge management system and a review of the legal aspects related with know-how management.



## 10. Exploit the opportunities from international collaborations

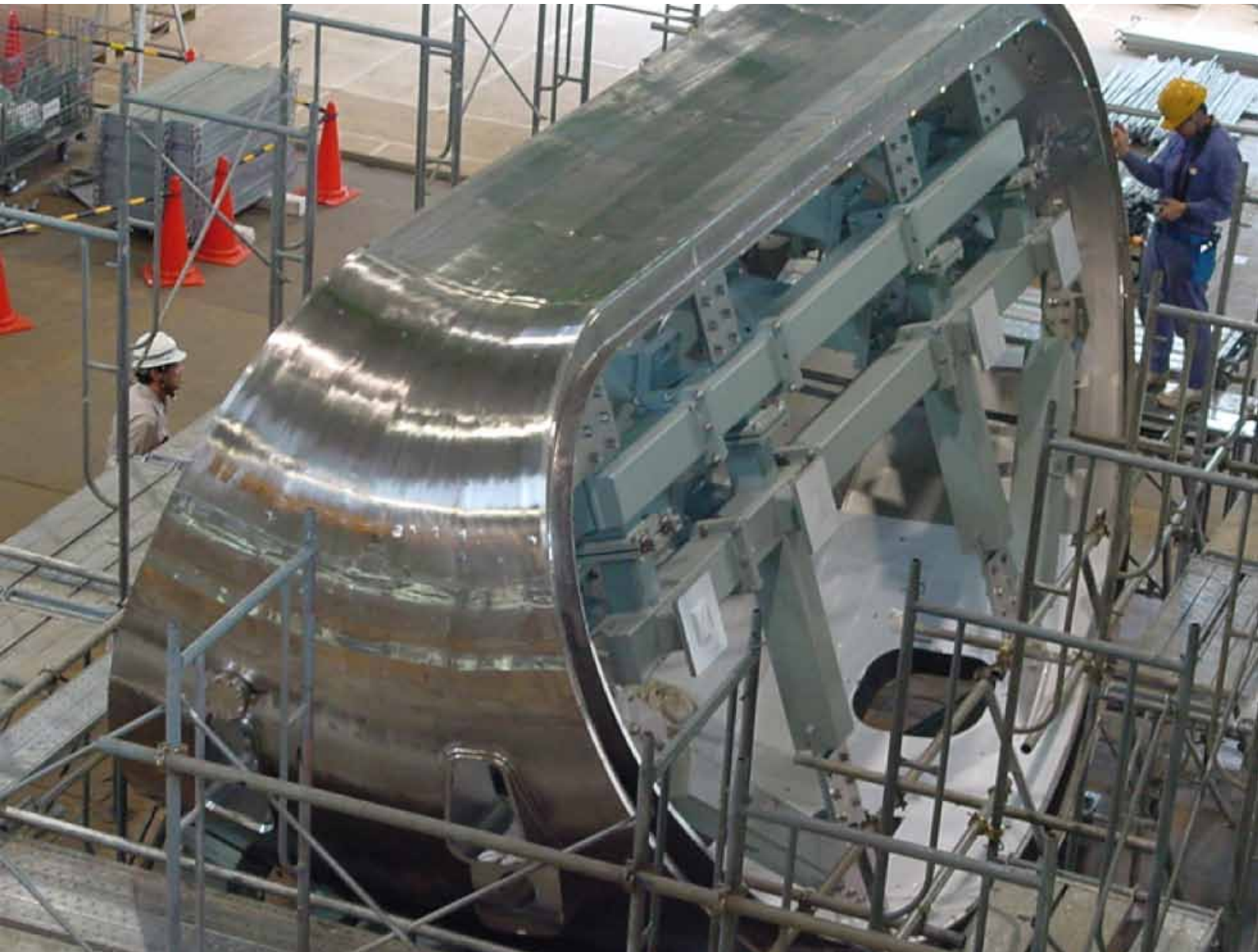

*The first 40° sector of the JT-60SA vacuum vessel was completed in June 2011 at JAEA Naka Fusion Institute, JAPAN. (Picture: JT-60SA)*

Europe should seek all the opportunities for international collaborations in order to gain from the intellectual diversity of the rest of the fusion community and from the sharing of resources. Some of the ITER parties have a very aggressive programme in fusion and Europe can clearly benefit from the participation in the design, construction and operation of their facilities. Already the Broader Approach with Japan is a good example of a positive collaboration that can give further advantages on the time scale considered here. It should be noted however that Europe at the moment has still a leading position in fusion research and that the demonstration of electricity from fusion by 2050 requires maintaining such a leadership role.

In order reap real benefits of international collaborations, if pursued, they should be established within a framework which ensures reasonable project management efficiency.

In addition to the ITER exploitation and the BA projects, the following opportunities are underlined:

- The exploitation of JT-60SA in collaboration with Japan for the preparation of ITER Phase 2;
- The construction of an early neutron source in collaboration with Japan within a post EVEDA phase;
- The collaboration on a joint DTT facility (US and Japan have also advocated the need for such a facility);
- The collaboration on other smaller scale DEMO R&D (for example making use of the infrastructure developed with Japan during the BA for that purpose);
- The use of the CFETR facility with China or the Fusion Neutron Science facility with US;
- Possible sharing of know-how on the TBM programme with other ITER parties whenever a win-win situation is expected;
- The use of non-EU research fission reactors
- The collaboration on stellarator lines other than the HELIAS (i.e. Heliotron and compact stellarator).

Europe can offer to the other parties the participation in its facilities, and specifically in JET as training facility for ITER. Specific funds (e.g. mobility) should also be allocated to support the collaboration on the facilities of international collaborators listed in Annex 1 both for Mission 1 and 2 and the basic research activities.



# 11. A living document: Roadmap reviews and decision points



Thinkstock

The present roadmap relies on the assumption that the budget described below will be made available. The decisions with the largest impact on the proposed Horizon 2020 programme are:

- The decision on the internationalisation of JET. The elements for this decision are expected to come by the end of FP7;
- The decision to extend and possibly enlarge the scope of BA activities to be undertaken with Japan (which may in turn include the items below);
- The decision on the implementation of the programme for Mission 2; and
- The decision on the early neutron source.

This document has to be seen as a living document, with periodic update and reviews to be performed at appropriate time. In the following the updates considered mandatory are listed.

A first review should be made early in Horizon 2020 (say by 2015) when the elements to take decisions on the above points will be available.

A second review could be made at the end of Horizon 2020 (say by 2019). This review will mainly have to assess the outcome of the conceptual design activity of DEMO, including R&D results, and decide if there are enough elements to progress towards the engineering design activity for DEMO and the costs involved. This review should involve utilities and vendors as for the Gen IV programme to ensure that before launching engineering design activities, there is full acceptance of the proposal by these stakeholders. A specific point will be the assessment of whether a test of a blanket module different from those under test within the ITER TBM programme is necessary.

A review around 2025 will be necessary to assess the progress of the DEMO EDA.

A review in 2029 to assess readiness for DEMO construction. The working assumption is that Europe should have by 2030 all the know-how necessary to build a DEMO reactor. The possibility of DEMO as an international experiment would have to be considered at an early stage.

## 12. Resources

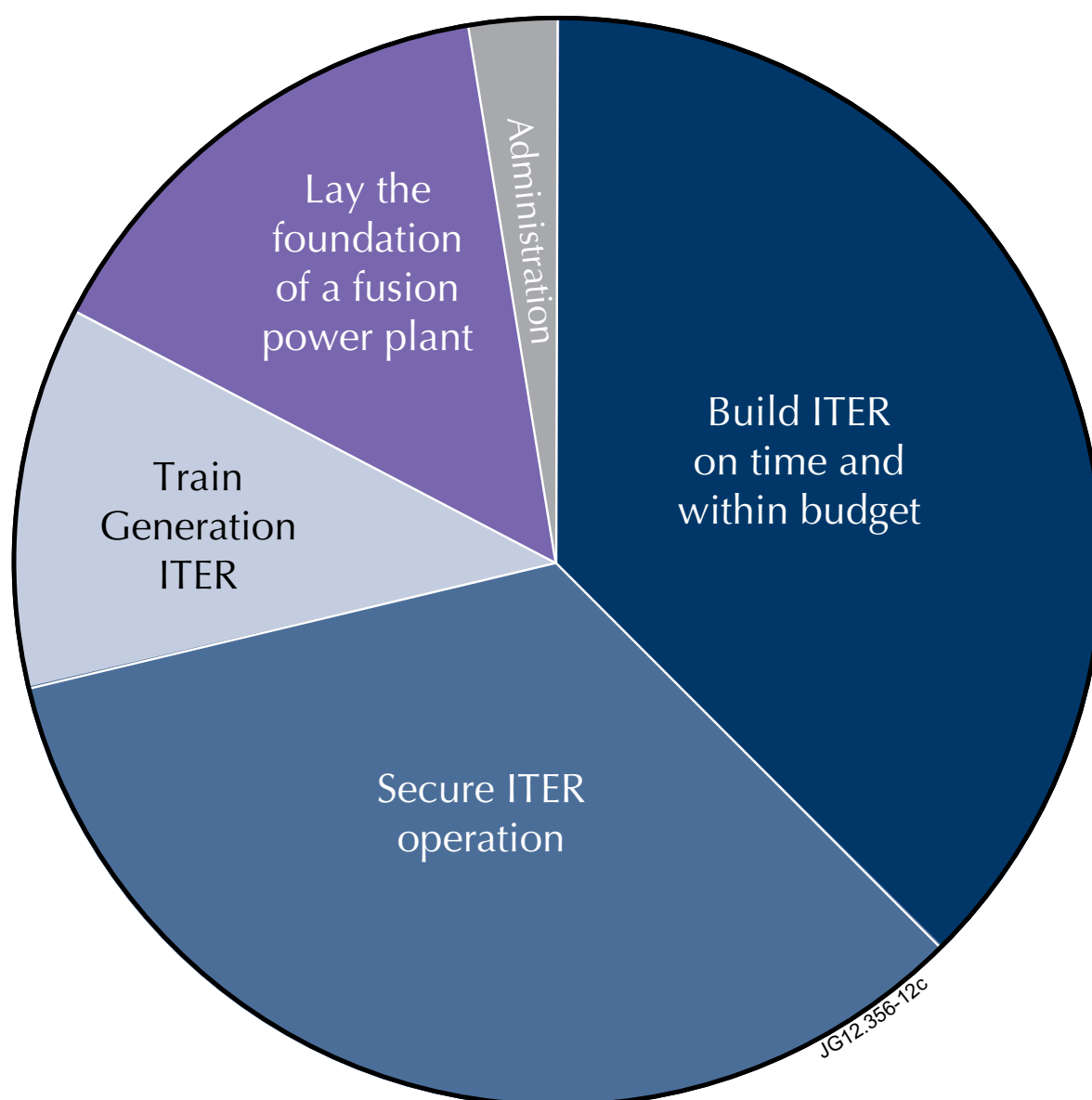

*Distribution of the human resources to the various objectives of the fusion roadmap during Horizon 2020.*

The total amount of resources required for the proposed roadmap are shown in Table 1 and detailed in Annex 11. The main assumptions are listed below.

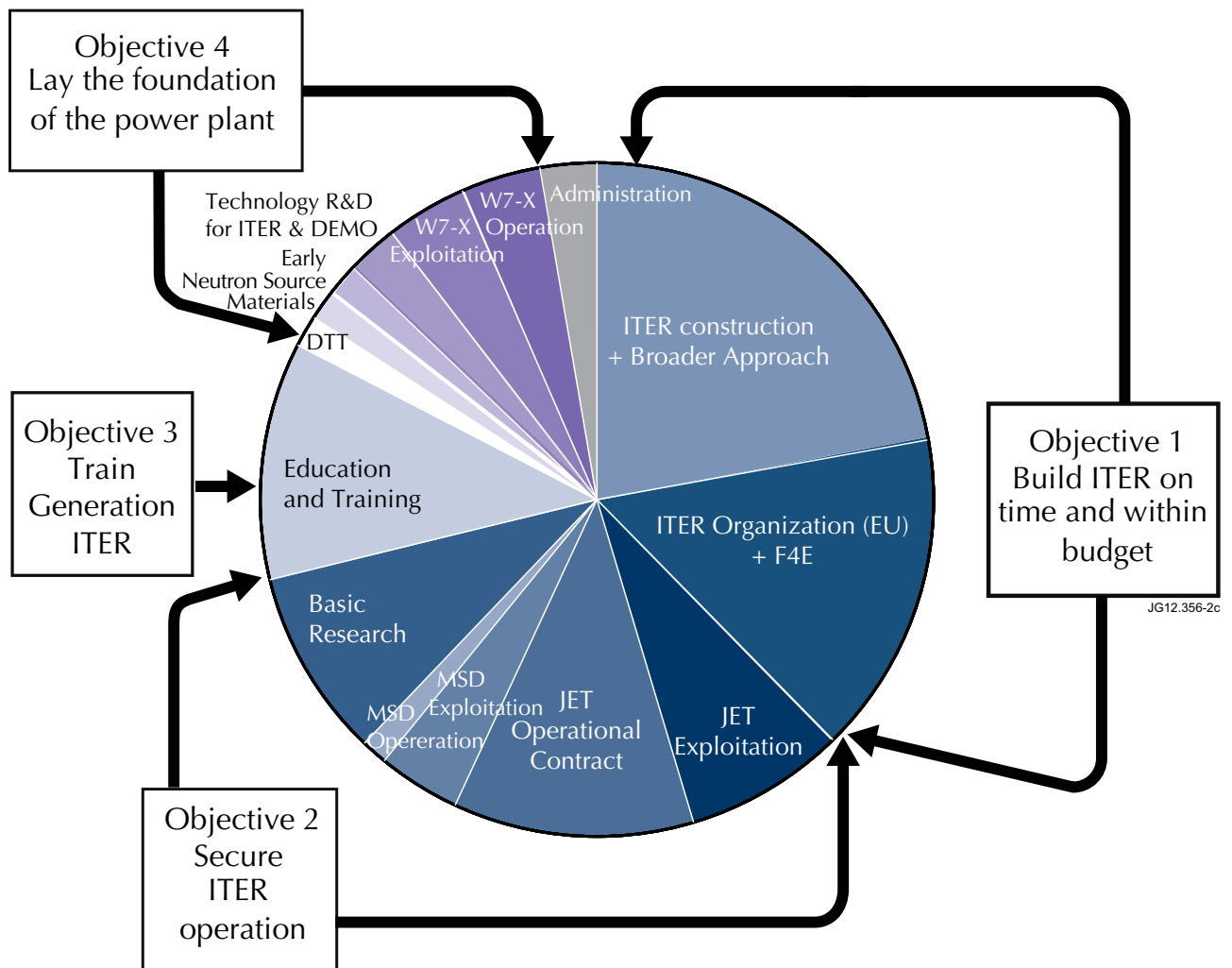

*Distribution of human resources (py/y) among the various roadmap activities and Objectives in Horizon 2020 (Abbreviations: MSD: medium sized devices; DTT: Divertor Tokamak Test Facility).*

**ITER.** ITER construction will progress according to the present plan. The F4E contribution during Horizon 2020 corresponds to an average of 397M€/y but in the last two years of Horizon 2020 will decrease to 208M€ and 21M€ respectively. The resources estimated by F4E for the design and R&D through grants and services in the different areas of the ITER construction are 450ppy/y. In addition, about 100ppy/y are already involved on the Broader Approach (BA) projects. The total amount of human resources on ITER and BA in the Associate laboratories, including support staff, is estimated as 850 py/y. In addition ~300 py/y from Europe are expected to work in both IO and F4E. For the period 2020-2030 the exploitation of ITER by European scientists, starting in 2021, is assumed to be implemented using the present JET provisions and to involve 400ppy/y<sup>20</sup>. Furthermore, the annual cost of ITER operation is assumed by IO to be 188 kilo ITER Units of Account (~291M€) with a EU share of 34%. One major ITER enhancement of 200M€ (e.g. for the addition of 20MW ECRH) is considered for the period 2021-2025. The European contribution is also assumed to be 34%. The cost of a new full tungsten wall will have to be properly evaluated after an assessment of its feasibility and is not included here.

**JET.** JET is assumed to operate until 2019, provided the process of internationalisation is successful, as suggested by the Panel on *Strategic Orientations of the Fusion Programme*, using the present framework with an average of 120 days of operation per year (double shift) and to be wound up in 2020. The savings in the operation cost resulting from the internationalisation are not explicitly included since they are difficult to quantify at this stage, although it is expected that they will lead to a significant contribution to the overall fusion programme. JET exploitation will require 300ppy/y with 10% of the effort for on-site work and the rest for analysis. Major enhancements, if approved, are assumed to be provided by international collaborators and are not accounted for in Table 1. The cost of the JET Operation Contract (JOC) is assumed to remain at the level of 56M€/y. The Order value is assumed 3M€/y (equivalent to 30ppy/y @ 100k€ each). The cost of the secondment allowance for Campaigns is evaluated at 1.5M€ (50k€ for 30ppy/y).

**Medium sized tokamaks and other Plasma Wall Interaction (PWI) facilities.** The assumed contribution to the work packages from medium sized tokamaks corresponds to 40 days of operation per year evaluated on the basis of the ASDEX Upgrade costs and 150ppy/y (2/3 in Mission 1 and 1/3 in Mission 2) with 10% of the effort for on-site work and the rest for analysis. The cost for facility use is evaluated at ~15M€/y including the cost of personnel for operation. This includes also the use of linear PWI devices.

**JT-60SA.** The exploitation of JT-60SA is expected to involve 100ppy/y with 10% of the effort for on-site work starting from 2019. Similar provisions as for JET orders and secondments are assumed. The cost to the EU of JT-60SA operation is assumed 25% of 60M€/y (i.e. 15M€/y) with operation for 2/3 of the year in 2019 and full operation from 2020 onwards. Enhancements to JT-60SA for a total of 80M€ (25% European contribution, i.e. 20M€) is assumed during the period 2021-2025. This is considered enough for an upgrade of the auxiliary heating system. The additional cost for a tungsten-wall will have to be properly evaluated.

**DTT.** A total of 300M€ for capital investments and personnel for construction over the period 2017-21. Preparatory design and R&D activities in the period 2014-16 for a total of ~11M€ is assumed. Operation costs are assumed 15M€/y starting in 2022. Exploitation should involve ~200ppy/y.

<sup>20</sup> In reality, it is expected that the effort on JET data analysis will continue a few years after the JET winding up, while the effort on ITER will progressively increase.



**Early neutron source.** The cost of the experiment depends on the location and the scope of the facility. Two options for the site have been preliminarily considered: The Rokkasho site and the green-field option. Three solutions with different scope have been considered: a simple 3-stage facility with a reduced lithium target; a single beam version of IFMIF; and a 40MeV, reduced current version with a carbon target (as possible risk mitigation measure). All three have very similar costs. The cost, however, depends on where the project is located and, including manpower and contingencies, ranges between ~160M€ for the 3-stage/Rokkasho option and ~360M€ for the single beam/green-field option. A figure of 200M€ has been assumed here. The construction is assumed to take place between 2017 and 2021. A figure of 20M€ /y has been assumed for operation and exploitation of the facility. The cost included in the table is the overall cost of the project and will have to be properly split between Europe and Japan.

**Material research.** Material research is assumed to involve 75ppy/y in 2014-2018 raising to 90ppy/y in 2019-2020 and to 100ppy/y in 2021-2030. The various packages for baseline and risk-mitigation material developments have been separately costed as described in Annex 3. Synergies expected with other Community programmes (such as the Research Fund for Coal and Steel) are not included in the present tables.

**Technology projects (Missions 4-7).** Each work package has been separately evaluated. The total amount for Horizon 2020 is broadly consistent with the amount of work carried out during the ITER CDA undertaken by the NET team. For the period 2020-2030 the main cost will arise from the DEMO EDA. Different estimates have been done here, both by evaluating the individual work packages and by using the global amount of resources for the ITER EDA, corrected for inflation. The two approaches lead to similar results and correspond to about 2B€ over the period 2020-2030 and 200ppy/y. The exact scope of the activities in Mission 7 will depend on the analysis of the activities in the other missions with the possibility of shifting some activity here in case the assessment shows that they are not mature enough to be pursued on the DEMO time scale. A provisional figure of 5M€/y has been assumed for the period beyond 2020.

**Industrial involvement.** About 20ppy/y from industry are expected to work through individual contracts for DEMO design and material-related activities in Horizon 2020.

**Stellarator research** The cost of operation of W7-X is estimated in 30M€/y (35M€/y from 2019). The exploitation is expected to involve 150ppy/y with 10% of the effort for on-site work covered by mobility.

**High performance computing.** A new High Performance Computer is foreseen after the end of the IFERC (International Fusion Energy Research Centre). An investment of 30M€ every 5 years is expected. Supporting activities for modelling at the level of 15ppy/y (High level Support Team, Gateway, etc.) are also included.

**Basic research.** The resources required here have been estimated as 350ppy/y, equivalent to 35M€/y at 100k€/ppy.

The total amount of resources is compatible with the amount presently invested, in addition to the ITER construction, by the EURATOM member states and the European Commission (between 350M€/y and 400M€/y) with a 10% increase in the third period. The amount of human resources is also comparable with those presently available in the programme, but a progressive shift towards technology is foreseen. In Annex 11 different scenarios for the programme funding are presented.

Annex 11 also discusses a hypothesis for the EURATOM funds. The resulting financial figures are presented in the figure below. Note that the increase in the last two years of Horizon 2020 (that are outside the framework of the next EURATOM five-year programme) occurs at the time of the completion of the ITER construction with a corresponding decrease of funding from 397M€ /y in 2014-2018 to 115M€ /y in 2019-2020.

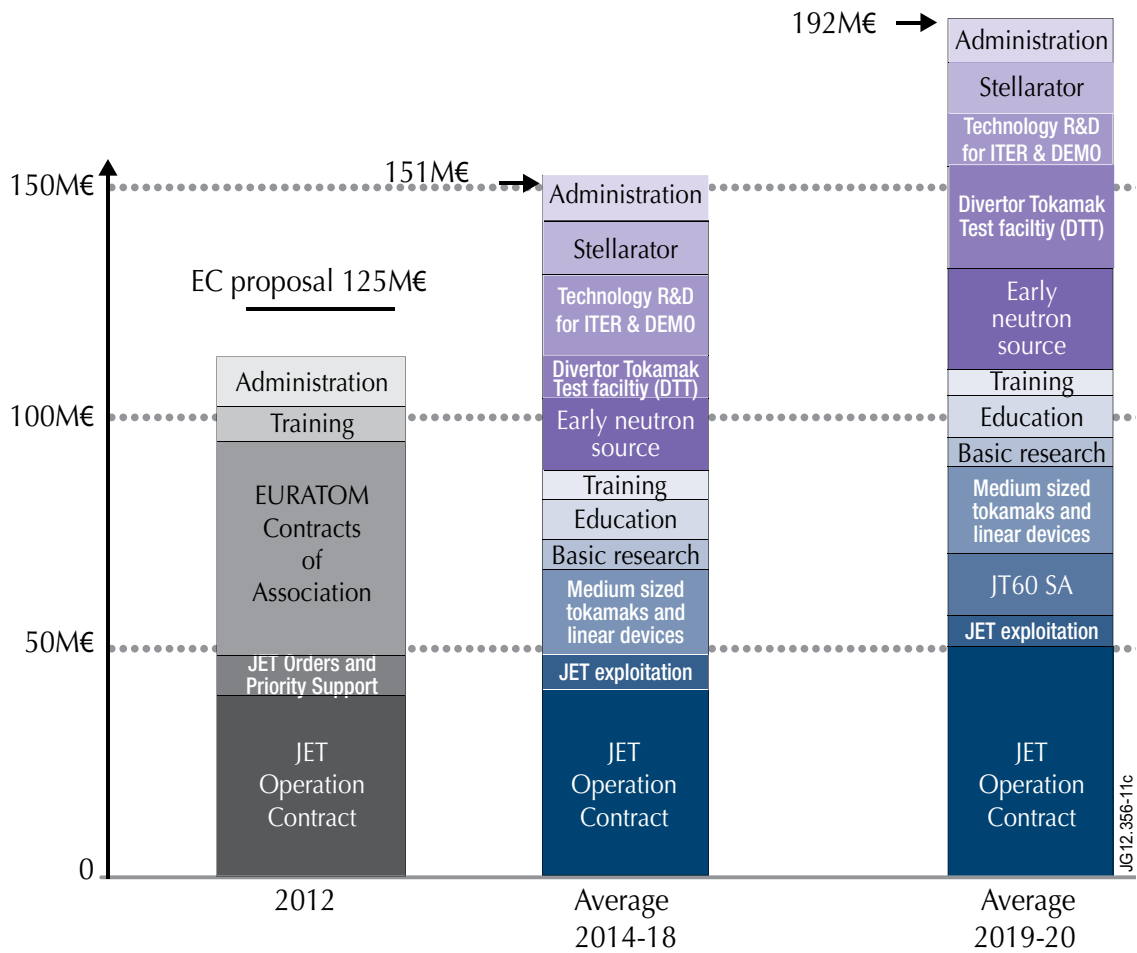

Average distribution of European Commission resources among the various roadmap activities (outside the ITER construction) together with the figure of 125M in the European Commission proposal for Horizon 2020<sup>21</sup>.

<sup>21</sup>Proposal for a COUNCIL DECISION establishing the Euratom Research and Training Programme (2014-2018) contributing to the implementation of the 'Horizon 2020' Framework Programme for Research and Innovation.

	2014-2018 average	2019-2020 average	2021-2030 average
	M€	M€	M€
Mission 1 w/o JET & ITER	20	33	33
Mission 2 w/o JET & ITER	36	70	44
Mission 3	39	67	33
Mission 4 w/o JET & ITER	19	14	In Mission 6
Mission 5	3	2	In Mission 6
Mission 6	13	9	200
Mission 7	5	5	5
Mission 8	45	50	50
Basic research	35	35	35
Computing resources	8	2	8
Education	9	9	9
Training	15	15	15
Administration & Mobility	10	10	10
JET operation	56	68	0
JET exploitation	32	30	0
<b>TOTAL w/o ITER</b>	<b>344</b>	<b>418</b>	<b>441</b>
ITER construction	511	115	0
ITER operation	0	0	99
ITER exploitation	0	0	42
ITER & JT60SA enhancement	0	0	9

Table 1. Evolution of the resources for the reference case. All the figures are at 2011 value.



## Annexes

- Annex 1. Mission 1 – Plasma regimes of operation of a fusion power plant
- Annex 2. Mission 2 – Heat and particle exhaust
- Annex 3. Mission 3 – Neutron resistant materials
- Annex 4. Mission 4 – Tritium self-sufficiency and fuel cycle
- Annex 5. Mission 5 – Implementation of fusion safety aspects
- Annex 6. Mission 6 – Integrated DEMO design and system development
- Annex 7. Mission 7 – Competitive cost of electricity.
- Annex 8. Mission 8 – Stellarator development
- Annex 9. Education and training needs in support of the EU fusion roadmap
- Annex 10. Opportunities for basic research
- Annex 11. Resources and implementation scheme
- Annex 12. Industrial involvement in the realisation of fusion as an energy source
- Annex 13. International collaborations for the development of Fusion Energy
- Annex 14. Risk Register
- Annex 15. Work Packages
- Annex 16. Roadmap Gantt chart

## Acknowledgments.

The EFDA STAC members are kindly acknowledged for reading and commenting on the manuscript. The authors want to thank also the ITER Organization for its input and the experts from F4E, the Fusion Industry Innovation Forum, the EFDA Associates and the EFDA Close Support Units who have contributed to the material in the Technical Annexes. The participants to the Roadmap Workshop held in Garching on 25-26 July 2012 are also thanked for the lively discussion and comments.



## Glossary

### Advanced tokamak operation

The baseline operating regime for ITER is the H-mode, which is characterised by strong ELM activity. Advanced regimes represent a step beyond this baseline regime in which the energy confinement is further improved, relative to that expected in H-mode. An important characteristic of the advanced regime is that it has a high self-driven current fraction, which minimises the need for external current drive methods, and makes it more suited to continuous operation of a power plant.

### Balance of Plant

The “balance of plant” of a system is the components not included in the primary system itself, including blowers, compressors and pumps, and other necessary but not primary components.

### Blanket

In a fusion power plant, the blanket is the system surrounding the plasma used to slow down the neutrons produced, so that the heat released can be used for electricity generation. The blanket is also used to synthesise tritium (from the neutrons and a lithium compound) to use as fuel.

### CFETR

Chinese Fusion Engineering Testing Reactor with the aim of demonstrating the full cycle of fusion energy in long pulse or steady-state operation, with tritium self sufficiency.

### DEMO

Demonstration power plant(s) envisaged to follow ITER.

### Disruption

A complex phenomenon involving plasma instabilities which results in rapid heat loss and termination of a tokamak discharge. Plasma control may be lost, in which the apparatus may be damaged, particularly in large machines. This phenomenon places a limit on the maximum density, pressure and current in a tokamak.

### Divertor

A magnetic field configuration affecting the edge of the plasma confinement region, designed to divert impurities/helium ash to a target chamber (this chamber is also often called the ‘divertor’). This is an alternative to using a limiter to define the plasma edge.

### Dpa (displacements per atom)

In irradiation damage the conventional unit of neutron fluence is displacements per atom (dpa). This measure of damage is a calculated value, derived from neutron transport calculations and a model of scattering recoils. Proposed fusion structural materials may be able to withstand about 100 dpa over their lifetime. This implies that each atom is displaced from its lattice site one hundred times on average.

### Edge Localised Mode (ELM)

An instability that often occurs in short periodic bursts during H-mode in divertor tokamaks. It causes transient heat and particle loss into the divertor which can be damaging.

### Energy confinement time

The energy confinement time is the average time taken for the energy to escape the plasma, usually defined by the ratio of the energy stored and the power loss.

### EUROFER

Ferritic martensitic steel with special properties, so it is the reference steel for the development of components in fusion power plants, with limited irradiation induced swelling and susceptibility to the production of helium (due to neutron bombardment) and can be made with low activation chemical compositions.

### EVEDA

Engineering Validation and Engineering Design Activity for IFMIF.

### Ferritic-Martensitic steels

Magnetic alloys which, when modified to improve their ductility, represent the most promising structural material for the first generation of fusion power plants. In microscopic terms they have a body centred cubic lattice structure; such structures are thought to have the highest resistance to embrittlement under irradiation.

### Fusion gain

Ratio between the power produced by the fusion reactions and the external power required to sustain them. A Fusion power plant requires a fusion gain ( $Q$ ) between  $Q=10$  and 50.

### H-mode

The H-mode is a high confinement regime that has been observed in tokamak plasmas. It develops when the plasma is heated above a characteristic power threshold, which varies with density, magnetic field and machine size. The H-mode is characterised by a sharp temperature gradient near the edge and typically a doubling of the energy confinement time compared to the normal L-mode. ELMs are often observed in this regime.

### IFMIF

The International Fusion Materials Irradiation Facility (IFMIF) is a proposed device that would test the structural integrity of fusion power plant materials under appropriate irradiation damage conditions. The detailed design and prototyping are being undertaken by Europe and Japan as a Broader Approach project.

### Inductive regimes of operation

Tokamak operation regime, where most of the toroidal plasma current required for plasma confinement is driven inductively by the magnetic flux swing produced by the transformer. This regime is characterised by a limit in the pulse duration, leading to pulsed operation of the tokamak; in contrast to steady state tokamak operation that requires the current to be driven non-inductively.

### Liquid metals as plasma facing components

The concept of replacing some solid tokamak plasma facing components with liquid components, aiming at increasing quasi-stationary heat fluxes removal capability, avoiding the melting, cracking and other damages that occur in solid components.

### ODS steels

Oxide dispersion strengthened alloys are intended to be used for high temperature applications and have potential against helium embrittlement. The development of suitable low activation ODS steels would allow the operation of the Fusion Power Plants at higher temperature, aiming at higher thermodynamic efficiency.

### RAMI

RAMI stands for Reliability, Availability, Maintainability and Inspectability. It describes a process whose primary purpose is to make sure that all the systems of a machine will be reliable during the operation phase and maintain their performance under operational conditions with the best possible availability.

### Snowflake Divertor

Divertor configuration which makes use of a second-order null of the poloidal field (poloidal field and poloidal field variation equals to zero) to improve performance; by the larger flux-expansion near the poloidal field null, increased connection length allowing radiative cooling before the plasma reaches the target.

### Steady-state regimes of operation

Steady State tokamak operation that requires the plasma current to be driven non-inductively.

### Stellarator

A magnetic confinement device in which the poloidal magnetic field is generated by external helical coils, in contrast to the tokamak in which the poloidal magnetic field is generated by an externally driven plasma current.

### Super-X divertor

A divertor design in which the power per unit area striking material surfaces is reduced greatly. It requires a set of divertor coils that extends and controls a long plume of exhaust plasma. The length of the plume allows high radiative cooling before the plasma reaches the target. Also, the radius of the target is higher than in other designs, which increases the target area.

### TBM programme

The TBM Programme is a specific programme for the development of blanket modules for application in fusion power plants. ITER will test a number of concepts through the implementation of the Test Blanket Module Programme under the ITER agreement.

## Authors



**Francesco Romanelli**  
EFDA Leader



**Pietro Barabaschi**  
Head of the F4E Broader  
Approach Department



**Duarte Borba**  
Responsible for International  
Collaborations in EFDA



**Gianfranco Federici**  
Head of the EFDA  
Power Plant Physics and  
Technology Department



**Lorne Horton**  
Head of the EFDA JET  
Department



**Rudolf Neu**  
Head of the EFDA ITER  
Physics Department



**Derek Stork**  
Vice Chair of the Power  
Plant Physics and  
Technology Implementing  
Agreement Board and Chair  
of the Material Assessment  
Group



**Hartmut Zohm**  
Chair of the Power Plant  
Physics and Technology  
Implementing Agreement  
Board

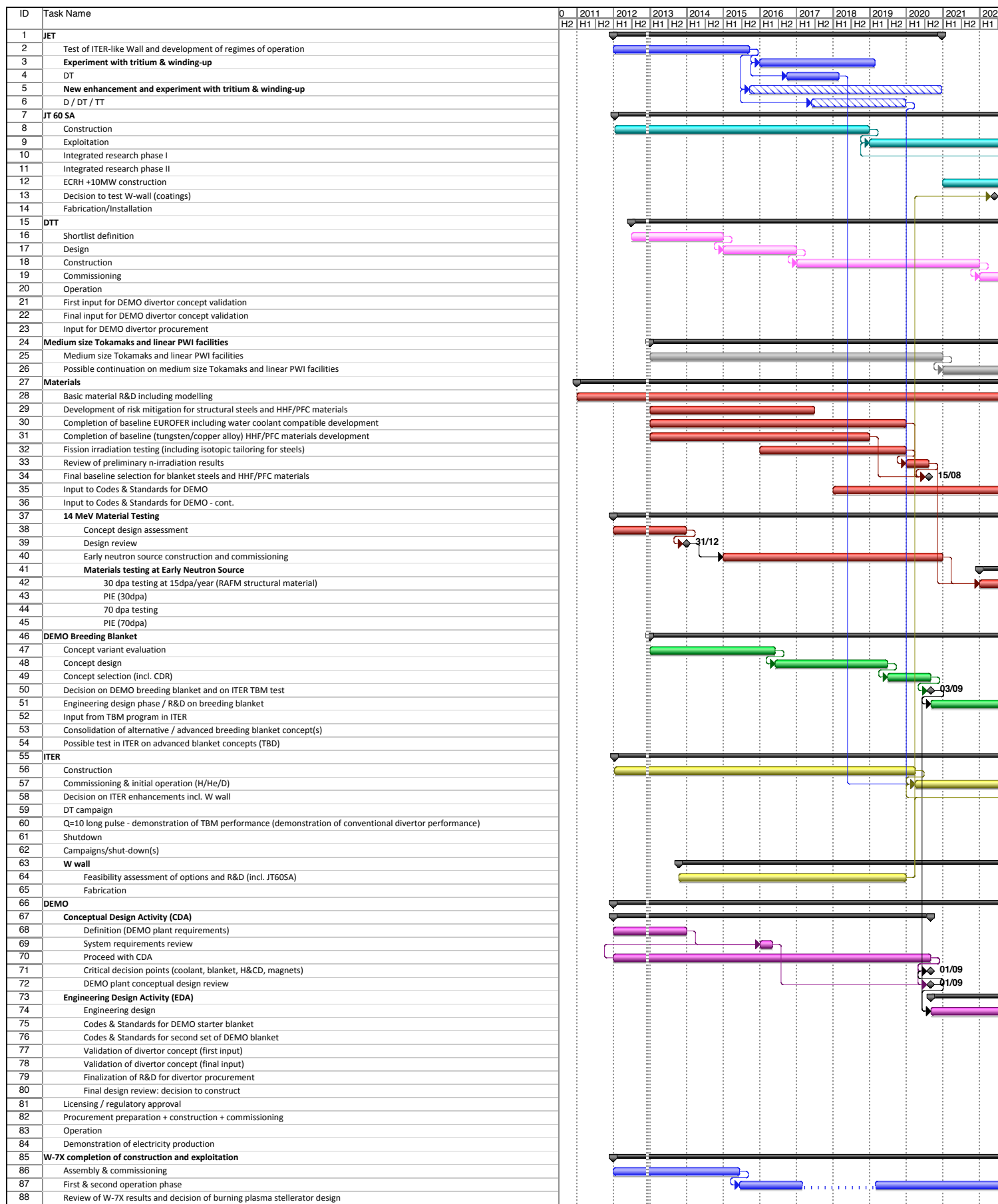

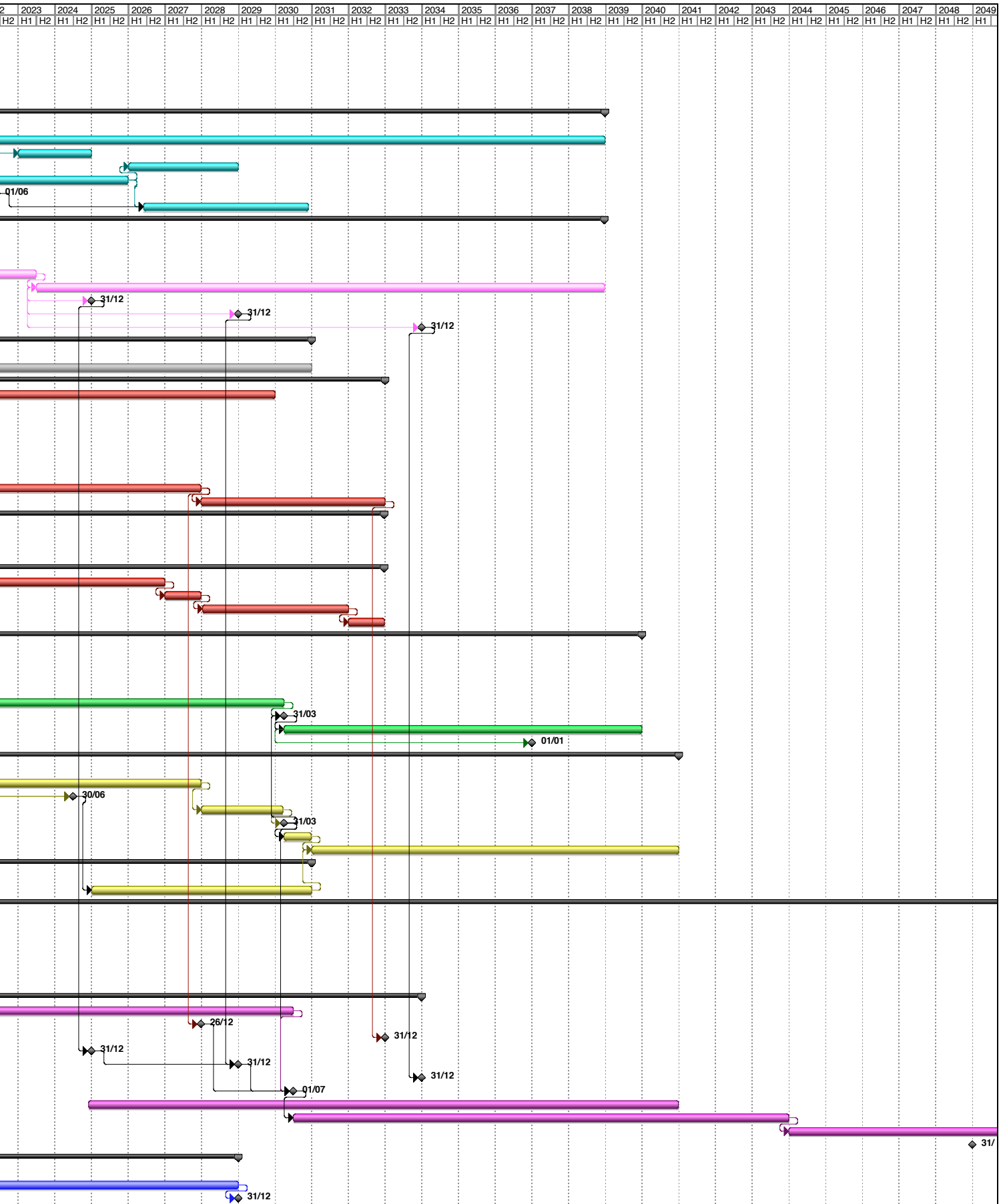

Project Summary
  External Tasks
  External Milestone

Deadline







European Fusion Development Agreement, EFDA  
[www.efda.org](http://www.efda.org)  
© francesco romanelli (EFDA Leader) 2012.

ISBN 978-3-00-040720-8

This document or parts of it may not be reproduced  
without permission.

Text, pictures and layout, except  
where noted, courtesy of EFDA

The EFDA parties are the European Commission  
and the Associates of the European fusion  
programme which is co-ordinated and managed by  
the Commission.

Neither the Commission, the  
Associates nor anyone acting on their behalf is responsible  
for any damage resulting from the use  
of information contained in this publication.

